

# CDFLEX

TUBI FLESSIBILI

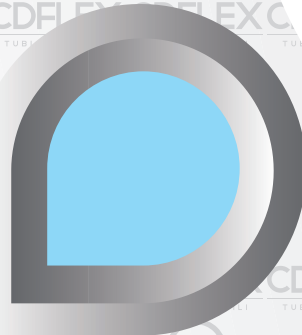

MADE IN ITALY



**Flessibili italiani di qualità**  
*Italian flexible hoses*

## LA STORIA / HISTORY



La **CDFLEX**, è un'importante realtà industriale, nella produzione di tubi flessibili per uso sanitario, flessibili per doccia e componenti per impianti idraulici e termosanitari. La nostra ditta opera in Via 1° Maggio Zona Ind. a Soriano Calabro da più di 15 anni ed è espressione del più prestigioso Made in Italy e della grande tradizione italiana nelle lavorazioni meccaniche ad elevato contenuto tecnologico: una qualità certificata e riconosciuta ISO 9001/2000. I nostri standard qualitativi, sono garantiti dall'utilizzo di materiali di elevata qualità, prodotti esclusivamente in Italia.

Lo scopo della nostra azienda è quello di soddisfare i nostri clienti, garantendo loro un prodotto di ottima qualità, frutto di numerosi controlli durante il ciclo produttivo.

La grande forza produttiva, un'organizzazione industriale "snella", innovativa, che unita ad una moderna concezione logistica, permettono alla CdFlex di soddisfare qualsiasi esigenza con consegne rapide in Italia e non solo. Tutto questo ci ha permesso di essere al passo coi tempi, e di raggiungere negli anni, importanti obiettivi di mercato.

*CDFLEX is an important industrial company, in the production of hoses for healthcare use, shower hoses and components for plumbing and thermal systems. Our company operates in Via 1 May Zona Ind. at Soriano Calabro for more than 15 years and is an expression of the most prestigious Made in Italy and the great Italian tradition in high-tech mechanical processes: a quality certified and recognized ISO 9001/2000. Our quality standards are guaranteed by the use of high-quality materials quality, produced exclusively in Italy.*

*The purpose of our company is to satisfy our customers, guaranteeing them a product of excellent quality, the result of numerous controls during the production cycle. The great production force, a "lean" industrial organization, innovative, that combined with a modern logistical concept, allow the CdFlex to meet any need with deliveries Italy and beyond.*

*All this has allowed us to keep up with the times, and to reach over the years, important market objectives.*



## CONTATTI / CONTACTS

**CDFLEX** s.r.l.s.  
Produzione tubi flessibili

 Via I° Maggio, Zona Industriale  
89831 Soriano Calabro (VV)

 **Tel.** +39 0963 352039  
**Fax:** +39 0963 351534

 **email:** [info@cdflex.it](mailto:info@cdflex.it)  
[www.cdflex.it](http://www.cdflex.it)



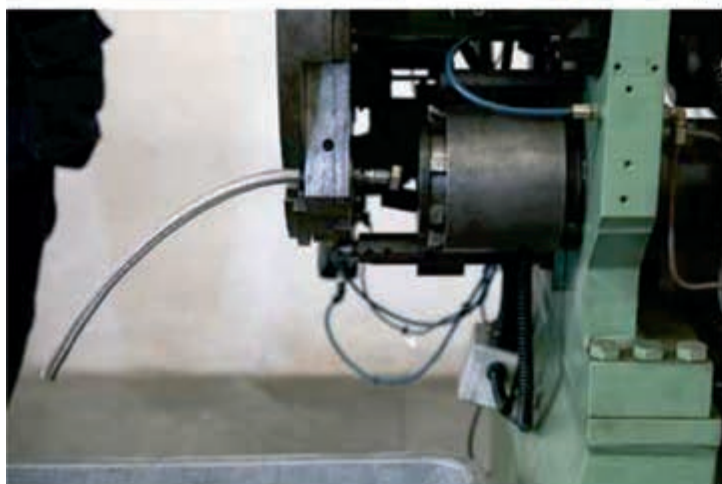

## CERTIFICAZIONI PRODOTTO / PRODUCT CERTIFICATION



Italia / Italy

Liner silicone conforme a:  
Silicon Linear conform to:

**VA APPROVAL** Danimarca / Denmark



Italia / Italy



Svezia / Sweden



Germania / Germany



## TUBO IN SILICONE

**Innovativo flessibile, ecologico, igienico**

*Innovative, eco-friendly, sanitary flexible hose\**

Flessibili di ultima generazione realizzati con materiali **ecologici** nel pieno rispetto dell'ambiente. Il linear interno garantisce ottima **resistenza** e massima **affidabilità** nel tempo.

*Latest generation flexible hoses made with **eco-friendly** materials, respecting the environment. Excellent **durability** and the highest **reliability** guaranteed by the new internal liner*



Dati tecnici:

Solo per uso idrosanitario

Temperatura d'esercizio da 5 °C a max 90°C

Pressione massima d'esercizio 10 bar

Garantito 10 anni

Differenti tipologie di raccordi

Diametri: DN6 - DN8

*Technical data:*

*For hydro-sanitary use only*

*Operating temperature range from 5°C to max 90°C*

*Max operating pressure 10 bar*

*10 years guarantee*

*Different fittings typologies*

*Diameter: DN6 - DN8*

DVGW KTW/A W270 ACS WRAS VA DN6 6,2X9,2 90° C

**\*Prodotto con quotazione a richiesta**

*\*Product with quotation only on request*

**Femmina (G=guarnizione inserita - a richiesta)**  
F. (G=inserted gasket - upon request)



**Maschio**  
Male



**Maschio prolungato con anello teflon**  
Extended male with teflon ring



**Maschio girevole 15x1**  
Swivel male 15x1



**Maschio girevole**  
Swivel male



**Maschio prolungato girevole**  
Extended swivel male



**Femmina Curva (G=guarnizione inserita - a richiesta)**  
Elbow F. (G=inserted gasket - upon request)



**Maschio tenuta OR 10x1 mm 18**  
8x1, 12x1 a richiesta  
Male with OR 8x1 mm 18  
10x1, 12x1 on request



**Maschio tenuta OR 10x1 mm 45-75**  
8x1, 12x1 a richiesta  
Male with OR 8x1 mm 45-75  
10x1, 12x1 on request



**Astina tubo liscio LR  $\phi$  10/9.7**  
 $\phi$  8 e  $\phi$  12 a richiesta  
Straight connector LR  $\phi$  10/9.7  
 $\phi$  8 and  $\phi$  12 on request



**Maschio bicono  $\phi$  10 calotta e ogiva 3 pz.**  
 $\phi$  8 e  $\phi$  12 a richiesta  
Compression male connect  $\phi$  10  
nut and ring 3 pcs.  
 $\phi$  8 and  $\phi$  12 on request



**Femmina conica 1/2" H 40 girevole**  
Swivel conical F. 1/2" H 40

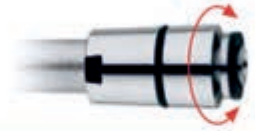

**Femmina conica 1/2" H 40 girevole**  
Swivel conical F. 1/2" H 40

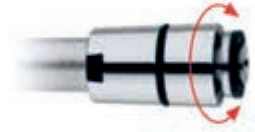

**Attacco rapido  $\phi$  10 e 12 e  $\phi$  15 a richiesta**  
Quick connection  $\phi$  10 e 12 and  $\phi$  15 on request



**Raccordi semisferici 1/4", 1/8", 3/8" per macchine caffè su richiesta**  
Cone-shaped tails 1/4", 1/8", 3/8" for coffee machines



**Raccordo femmina zigrinato**  
Knurled F.



**Femmina conica 1/2"**  
Conical nut 1/2"



## Diametri disponibili / Available diameters

### FLESSIBILI / FLEXIBLE HOSES

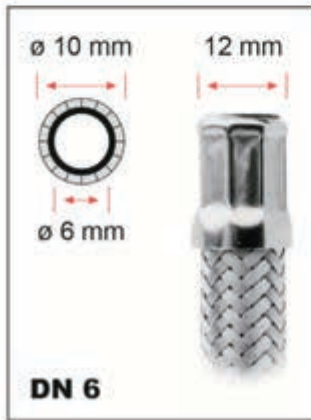

### ANTIVIBRANTI / ANTIVIBRATION HOSES



Prodotti affidabili e garantiti da CDflex.

Reliable products guaranteed by CDflex.



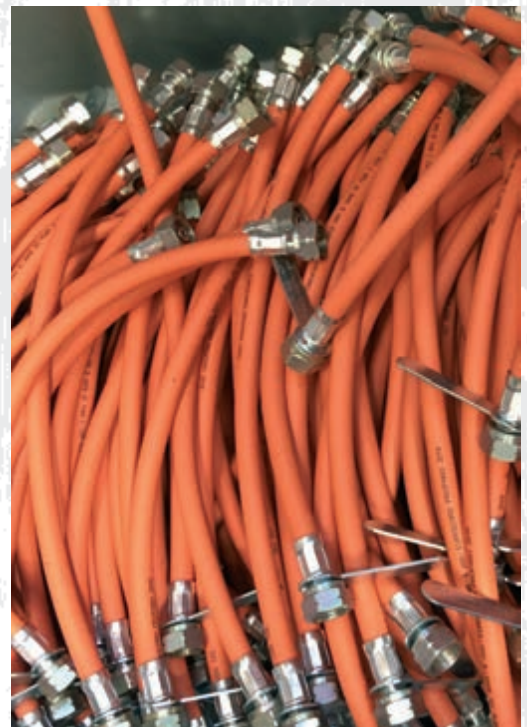
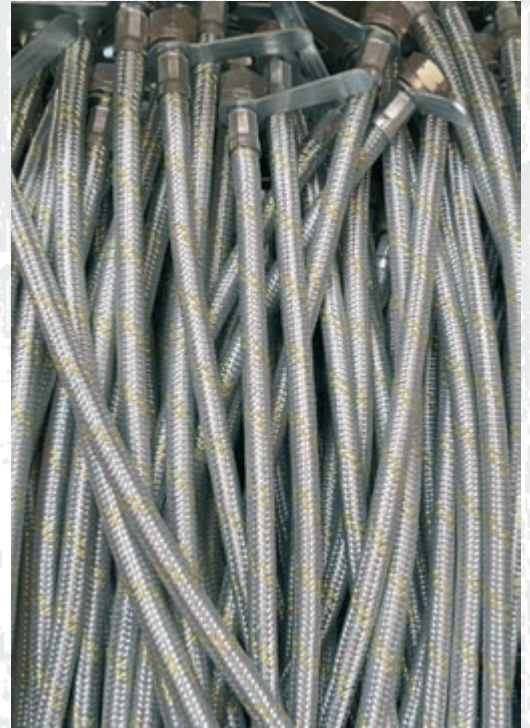

FLESSIBILI DN 6 .....	<i>pag.</i> 01 ●
FLESSIBILI DN 8 .....	<i>pag.</i> 04 ●
FLESSIBILI DN 10 .....	<i>pag.</i> 22 ●
FLESSIBILI DN 13 .....	<i>pag.</i> 44 ●
FLESSIBILI ANTIVIBRANTI .....	<i>pag.</i> 50 ●
FLESSIBILI ANTIVIBRANTI INOX .....	<i>pag.</i> 55 ●
FLESSIBILI GAS .....	<i>pag.</i> 60 ●
FLESSIBILI ACQUA E GAS <i>estensibili</i> .....	<i>pag.</i> 61 ●
KIT CALDAIA .....	<i>pag.</i> 62 ●
FLESSIBILI GAS <i>manichette</i> .....	<i>pag.</i> 63 ●
FLESSIBILI DOCCIA .....	<i>pag.</i> 65 ●
FLESSIBILI DOCCIA ESTRAIBILE .....	<i>pag.</i> 70 ●
FLESSIBILI PER CARICO LAVATRICE .....	<i>pag.</i> 73 ●
ACCESSORI PER RUBINETTERIA .....	<i>pag.</i> 75 ●



89831 Soriano Calabro (VV)  
Via 1° Maggio, Zona Industriale

**PER CHI VIENE DA NORD**

Autostrada A2 SA-RC uscita Serre

**PER CHI VIENE DA SUD**

Autostrada A2 uscita Serre





DN6  
DN6  
DN6  
DN6





DISPONIBILE SU RICHIESTA CON TRECCIA TRICOLORE

### DATI TECNICI - TECHNICAL DATA:

Tubo flessibile trecciato made in Italy in acciaio Inox AISI 304 con interno in gomma alimentare EPDM utilizzato per il collegamento tra la rete idrica e la rubinetteria sanitaria. Grazie alle dimensioni molto ridotte e alla pressatura su tutta la lunghezza della bussola, questo flessibile favorisce l'installazione su rubinetterie di qualsiasi design, specialmente quelle con un design molto minimale con degli spazi tecnici ridotti o poco accessibili. Tutti i flessibili sono raccordati con macchine automatiche ed il risultato è l'assoluta precisione di ogni pezzo prodotto per una garanzia di totale qualità.

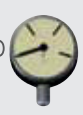
Made in Italy braided hose in AISI 304 stainless steel with internal in non-toxic EPDM rubber, used for the connection between the water mains and the sanitary fittings. Thanks to the very small size and the pressing all along the entire length of the sleeve, this hose facilitates the installation on faucets of any design, especially on those with a very minimal design with reduced engineering spaces or not very accessible. All the hoses are produced with automatic machines and the result is the absolute precision of each produced piece for a total quality guarantee.











### CARATTERISTICHE - FEATURES:

TEMPERATURA INSTALLAZIONE INSTALLATION TEMPERATURE 	PRESSIONE D'ESERCIZIO WORKING PRESSURE 	PORTATA A 3 BAR 	TEMPERATURA D'IMPIEGO WORKING TEMPERATURE 	FORO MINIMO PASSAGGIO D'ACQUA FITTING INNER DIAMETER 	RAGGIO CURVATURA MINIMO 
da -5°C a +90°C	10 BAR	19 lit/min	-5°C - +90°C	4,7 mm	25 mm











### MATERIALI - MATERIALS

TUBO HOSE		Ø INTERNO INNER Ø 6 mm	Ø ESTERNO OUTER Ø 10 mm	Treccia 6 fili Ø 0,20mm in acciaio INOX AISI 304 Tubo interno: gomma EPDM atossico. 6 wires braid Ø 0,20mm in stainless steel INOX AISI 304 Internal pipe: EPDM rubber, atoxic.
RACCORDI FITTINGS		CW614N		Ottone CW614N e CW617N nichelato o giallo Brass CW614N and CW617N nickel plated or yellow
BUSSOLE		Ø 12 mm		Acciaio INOX AISI 304 Stainless steel AISI 304













Tubo Flessibile	Treccia INOX	CODICE PRODOTTO	DESCRIZIONE	UDC MINIMA	UNITÀ DI VENDITA	PREZZI EUR escl. IVA
<b>M 10</b>	<b>F 3/8"</b>	RR 006.150	M 10 x F3/8 MM 150	50		1,79
		RR 006.200	M 10 x F3/8 MM 200	50		1,89
		RR 006.250	M 10 x F3/8 MM 250	50		2,00
		RR 006.300	M 10 x F3/8 MM 300	50		2,10
		RR 006.350	M 10 x F3/8 MM 350	50		2,20
		RR 006.400	M 10 x F3/8 MM 400	50		2,33
		RR 006.450	M 10 x F3/8 MM 450	50		2,64
		RR 006.500	M 10 x F3/8 MM 500	50		2,74
		RR 006.600	M 10 x F3/8 MM 600	10		2,96
		RR 006.800	M 10 x F3/8 MM 800	10		3,26
		RR 006.1000	M 10 x F3/8 MM 1000	10		3,46

Art. 006

<b>M 10</b>	<b>F 1/2"</b>	MS 217.150	M 10 x F1/2 MM 150	50		1,85
		MS 217.200	M 10 x F1/2 MM 200	50		1,96
		MS 217.250	M 10 x F1/2 MM 250	50		2,06
		MS 217.300	M 10 x F1/2 MM 300	50		2,17
		MS 217.350	M 10 x F1/2 MM 350	50		2,28
		MS 217.400	M 10 x F1/2 MM 400	50		2,39
		MS 217.450	M 10 x F1/2 MM 450	50		2,49
		MS 217.500	M 10 x F1/2 MM 500	50		2,70
		MS 217.600	M 10 x F1/2 MM 600	10		2,91
		MS 217.800	M 10 x F1/2 MM 800	10		3,34
		MS 217.1000	M 10 x F1/2 MM 1000	10		3,63

Art. 217

SOLO PER CASE RUBINETTERIA



Tubo Flessibile	Treccia INOX	CODICE PRODOTTO	DESCRIZIONE	UDC MINIMA	UNITÀ DI VENDITA	PREZZI EUR <i>escl. IVA</i>
<b>ML 10</b>	<b>F 3/8"</b>	RS 008.150	ML 10 x F3/8 MM 150	50		2,04
		RS 008.200	ML 10 x F3/8 MM 200	50		2,14
		RS 008.250	ML 10 x F3/8 MM 250	50		2,26
		RS 008.300	ML 10 x F3/8 MM 300	50		2,36
		RS 008.350	ML 10 x F3/8 MM 350	50		2,46
		RS 008.400	ML 10 x F3/8 MM 400	50		2,57
		RS 008.450	ML 10 x F3/8 MM 450	50		2,68
		RS 008.500	ML 10 x F3/8 MM 500	50		2,89
		RS 008.600	ML10 x F3/8 MM 600	10		3,10
		RS 008.800	ML 10 x F3/8 MM 800	10		3,52
		RS 008.1000	ML 10 x F3/8 MM 1000	10		3,87



Art. 008

**ML 10**

**F 1/2"**

	RD 010.150	ML 10 x F1/2 MM 150	50		2,10
	RD 010.200	ML 10 x F1/2 MM 200	50		2,22
	RD 010.250	ML 10 x F1/2 MM 250	50		2,32
	RD 010.300	ML 10 x F1/2 MM 300	50		2,42
	RD 010.350	ML 10 x F1/2 MM 350	50		2,52
	RD 010.400	ML 10 x F1/2 MM 400	50		2,64
	RD 010.450	ML 10 x F1/2 MM 450	50		2,74
	RD 010.500	ML 10 x F1/2 MM 500	50		2,96
	RD 010.600	ML 10 x F1/2 MM 600	10		3,18
	RD 010.800	ML 10 x F1/2 MM 800	10		3,89
	RD 010.1000	ML 10 x F1/2 MM 1000	10		4,09

Art. 010

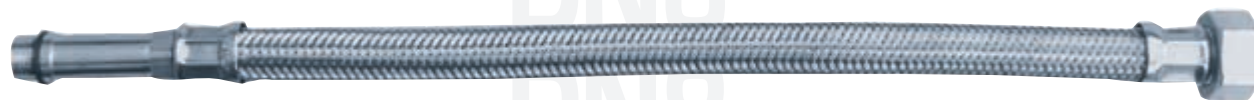







DISPONIBILE CON TRECCIA TRICOLORE

### DATI TECNICI - TECHNICAL DATA:

Tubo flessibile trecciato made in Italy in acciaio Inox AISI 304 con interno in gomma alimentare EPDM utilizzato per il collegamento tra la rete idrica e la rubinetteria sanitaria o cassette W.C. e adatto a qualsiasi altro impiego sanitario. Tutti i flessibili sono raccordati con macchine automatiche ed il risultato è l'assoluta precisione di ogni pezzo prodotto per una garanzia di totale qualità.

*Made in Italy braided hose in AISI 304 stainless steel with internal in EPDM rubber, used for the connection between the water mains and the sanitary fittings or W.C. flushing tanks. All the hoses are produced with automatic machines and the result is the absolute precision of each produced piece for a total quality guarantee.*











### CARATTERISTICHE - FEATURES:

TEMPERATURA INSTALLAZIONE <small>INSTALLATION TEMPERATURE</small> 	PRESSIONE D'ESERCIZIO <small>WORKING PRESSURE</small> 	PORTATA A 3 BAR <small>FLOW RATE AT 3 BAR</small> 	TEMPERATURA D'IMPIEGO <small>WORKING TEMPERATURE</small> 	FORO MINIMO PASSAGGIO D'ACQUA <small>FITTING INNER DIAMETER</small> 	RAGGIO CURVATURA MINIMO <small>MINIMUM BENDING RADIUS</small> 
da -5°C a +90°C	10 BAR	29 lit/min	-5°C - +90°C	6 mm	30 mm

### MATERIALI - MATERIALS







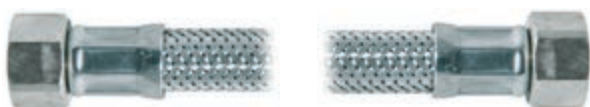



TUBO <small>HOSE</small> 	Ø INTERNO <small>INNER Ø</small> 8 mm	Ø ESTERNO <small>OUTER Ø</small> 12 mm	Treccia 7 fili Ø 0,22mm in acciaio Inox AISI 304 Tubo interno: gomma EPDM atossico. 7 wires braid Ø 0,22mm in stainless steel Inox AISI 304 Internal pipe: EPDM rubber, atoxic.
RACCORDI <small>FITTINGS</small> 	CW614N		Brass CW614N and CW617N nickel plated
BUSSOLE <small>SLEEVES</small> 	Ø 14 mm		Acciaio Inox AISI 304 Stainless steel AISI 304



Tubo Flessibile	Treccia INOX	CODICE PRODOTTO	DESCRIZIONE	UDC MINIMA	UNITÀ DI VENDITA	PREZZI EUR <i>escl. IVA</i>
<b>F 3/8"</b>	<b>F 3/8"</b>	MR 014.150	F3/8 x F3/8 MM 150	50		1,93
		MR 014.200	F3/8 x F3/8 MM 200	50		2,05
		MR 014.250	F3/8 x F3/8 MM 250	50		2,15
		MR 014.300	F3/8 x F3/8 MM 300	50		2,27
		MR 014.350	F3/8 x F3/8 MM 350	50		2,39
		MR 014.400	F3/8 x F3/8 MM 400	50		2,54
		MR 014.450	F3/8 x F3/8 MM 450	50		2,72
		MR 014.500	F3/8 x F3/8 MM 500	50		2,90
		MR 014.600	F3/8 x F3/8 MM 600	10		3,15
		MR 014.800	F3/8 x F3/8 MM 800	10		3,82
		MR 014.1000	F3/8 x F3/8 MM 1000	10		4,06













Art. 014

<b>F 1/2"</b>	<b>F 3/8"</b>	MN 015.150	F1/2 x F3/8 MM 150	50		1,85
		MN 015.200	F1/2 x F3/8 MM 200	50		1,96
		MN 015.250	F1/2 x F3/8 MM 250	50		2,06
		MN 015.300	F1/2 x F3/8 MM 300	50		2,17
		MN 015.350	F1/2 x F3/8 MM 350	50		2,28
		MN 015.400	F1/2 x F3/8 MM 400	50		2,39
		MN 015.450	F1/2 x F3/8 MM 450	50		2,49
		MN 015.500	F1/2 x F3/8 MM 500	50		2,70
		MN 015.600	F1/2 x F3/8 MM 600	10		2,91
		MN 015.800	F1/2 x F3/8 MM 800	10		3,34
		MN 015.1000	F1/2 x F3/8 MM 1000	10		3,63



Art. 015



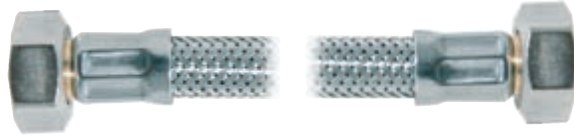

Tubo Flessibile	Treccia INOX	CODICE PRODOTTO	DESCRIZIONE	UDC MINIMA	UNITÀ DI VENDITA	PREZZI EUR <i>escl. IVA</i>
<b>F 1/2"</b>	<b>F 1/2"</b>	FM 016.150	F1/2 x F1/2 MM 150	50		2,12
		FM 016.200	F1/2 x F1/2 MM 200	50		2,23
		FM 016.250	F1/2 x F1/2 MM 250	50		2,35
		FM 016.300	F1/2 x F1/2 MM 300	50		2,46
		FM 016.350	F1/2 x F1/2 MM 350	50		2,59
		FM 016.400	F1/2 x F1/2 MM 400	50		2,73
		FM 016.450	F1/2 x F1/2 MM 450	50		2,84
		FM 016.500	F1/2 x F1/2 MM 500	50		3,00
		FM 016.600	F1/2 x F1/2 MM 600	10		3,23
		FM 016.800	F1/2 x F1/2 MM 800	10		4,02
		FM 016.1000	F1/2 x F1/2 MM 1000	10		4,19



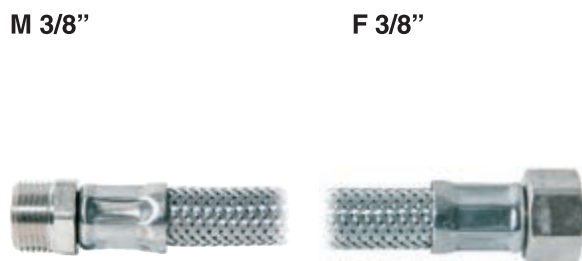









Art. 016













Art. 017

<b>M 3/8"</b>	<b>F 3/8"</b>	SF 017.150	M3/8 x F3/8 MM 150	50		2,02
		SF 017.200	M3/8 x F3/8 MM 200	50		2,14
		SF 017.250	M3/8 x F3/8 MM 250	50		2,25
		SF 017.300	M3/8 x F3/8 MM 300	50		2,37
		SF 017.350	M3/8 x F3/8 MM 350	50		2,48
		SF 017.400	M3/8 x F3/8 MM 400	50		2,62
		SF 017.450	M3/8 x F3/8 MM 450	50		2,74
		SF 017.500	M3/8 x F3/8 MM 500	50		2,90
		SF 017.600	M3/8 x F3/8 MM 600	10		3,14
		SF 017.800	M3/8 x F3/8 MM 800	10		3,93
		SF 017.1000	M3/8x F3/8 MM 1000	10		4,15

Tubo Flessibile	Treccia INOX	CODICE PRODOTTO	DESCRIZIONE	UDC MINIMA	UNITÀ DI VENDITA	PREZZI EUR escl. IVA
<b>MP 3/8"</b> <b>MASCHIO PROLUNGATO</b> <i>EXTENDED M3/8"</i>	<b>F 1/2"</b>	TT 066.150	MP3/8 x F1/2 MM 150	50		2,31
		TT 066.200	MP3/8 x F1/2 MM 200	50		2,38
		TT 066.250	MP3/8 x F1/2 MM 250	50		2,45
		TT 066.300	MP3/8 x F1/2 MM 300	50		2,56
		TT 066.350	MP3/8 x F1/2 MM 350	50		2,66
		TT 066.400	MP3/8 x F1/2 MM 400	50		2,76
		TT 066.450	MP3/8 x F1/2 MM 450	50		2,91
		TT 066.500	MP3/8 x F1/2 MM 500	50		3,05
		TT 066.600	MP3/8 x F1/2 MM 600	10		3,41
		TT 066.800	MP3/8 x F1/2 MM 800	10		3,95
		TT 066.1000	MP3/8 x F1/2 MM 1000	10		4,20







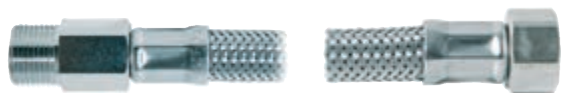





Art. 066

<b>MP 1/2"</b> <b>MASCHIO PROLUNGATO</b> <i>EXTENDED M 1/2"</i>	<b>F 3/8"</b>	TR 067.150	MP1/2 x F3/8 MM 150	50		2,36
		TR 067.200	MP1/2 x F3/8 MM 200	50		2,46
		TR 067.250	MP1/2 x F3/8 MM 250	50		2,51
		TR 067.300	MP1/2 x F3/8 MM 300	50		2,61
		TR 067.350	MP1/2 x F3/8 MM 350	50		2,71
		TR 067.400	MP1/2 x F3/8 MM 400	50		2,81
		TR 067.450	MP1/2 x F3/8 MM 450	50		2,96
		TR 067.500	MP1/2 x F3/8 MM 500	50		3,10
		TR 067.600	MP1/2 x F3/8 MM 600	10		3,45
		TR 067.800	MP1/2 x F3/8 MM 800	10		4,00
		TR 067.1000	MP1/2 x F3/8 MM 1000	10		4,30



Art. 067





Tubo Flessibile	Treccia INOX	CODICE PRODOTTO	DESCRIZIONE	UDC MINIMA	UNITÀ DI VENDITA	PREZZI EUR <i>escl. IVA</i>
<b>MP 1/2"</b> <b>MASCHIO PROLUNGATO</b> <i>EXTENDED M 1/2"</i>	<b>F 1/2"</b>	TP 068.150	MP1/2 x F1/2 MM 150	50		2,41
		TP 068.200	MP1/2 x F1/2 MM 200	50		2,48
		TP 068.250	MP1/2 x F1/2 MM 250	50		2,55
		TP 068.300	MP1/2 x F1/2 MM 300	50		2,65
		TP 068.350	MP1/2 x F1/2 MM 350	50		2,76
		TP 068.400	MP1/2 x F1/2 MM 400	50		2,86
		TP 068.450	MP1/2 x F1/2 MM 450	50		3,01
		TP 068.500	MP1/2 x F1/2 MM 500	50		3,15
		TP 068.600	MP1/2 x F1/2 MM 600	10		3,50
		TP 068.800	MP1/2 x F1/2 MM 800	10		4,08
		TP 068.1000	MP1/2 x F1/2 MM 1000	10		4,38



Art. 068







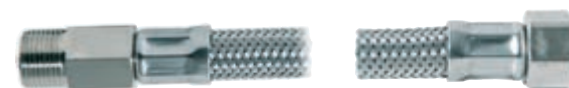



**MP 3/8"**  
**MASCHIO PROLUNGATO**  
*EXTENDED M 3/8"*

**F 3/8"**  
**CON GUARNIZIONE**  
**INSERITA**  
*INSERTED GASKET*

<b>MP 3/8"</b> <b>MASCHIO PROLUNGATO</b> <i>EXTENDED M 3/8"</i>	<b>F 3/8"</b> <b>CON GUARNIZIONE</b> <b>INSERITA</b> <i>INSERTED GASKET</i>	TV 069.150	MP3/8 x F3/8 MM 150	50		2,47
		TV 069.200	MP3/8 x F3/8 MM 200	50		2,52
		TV 069.250	MP3/8 x F3/8 MM 250	50		2,58
		TV 069.300	MP3/8 x F3/8 MM 300	50		2,62
		TV 069.350	MP3/8 x F3/8 MM 350	50		2,76
		TV 069.400	MP3/8 x F3/8 MM 400	50		2,91
		TV 069.450	MP3/8 x F3/8 MM 450	50		3,06
		TV 069.500	MP3/8 x F3/8 MM 500	50		2,20
		TV 069.600	MP3/8 x F3/8 MM 600	10		3,60
		TV 069.800	MP3/8 x F3/8 MM 800	10		4,15
		TV 069.1000	MP3/8 x F3/8 MM 1000	10		4,55













Art. 069

Tubo Flessibile	Treccia INOX	CODICE PRODOTTO	DESCRIZIONE	UDC MINIMA	UNITÀ DI VENDITA	PREZZI EUR <i>escl. IVA</i>
<b>MP 1/2"</b> <b>MASCHIO PROLUNGATO</b> <i>EXTENDED M 1/2"</i>	<b>F 1/2"</b> <b>CON GUARNIZIONE</b> <b>INSERTITA</b> <i>INSERTED GASKET</i>	TZ 070.150	M1/2 x F1/2 MM 150	50		2,51
		TZ 070.200	M1/2 x F1/2 MM 200	50		2,61
		TZ 070.250	M1/2 x F1/2 MM 250	50		2,66
		TZ 070.300	M1/2 x F1/2 MM 300	50		2,76
		TZ 070.350	M1/2 x F1/2 MM 350	50		2,81
		TZ 070.400	M1/2 x F1/2 MM 400	50		2,96
		TZ 070.450	M1/2 x F1/2 MM 450	50		3,11
		TZ 070.500	M1/2 x F1/2 MM 500	50		3,25
		TZ 070.600	M1/2 x F1/2 MM 600	10		3,75
		TZ 070.800	M1/2 x F1/2 MM 800	10		4,20
		TZ 070.1000	M1/2 x F1/2 MM 1000	10		4,65

Art. 070











<b>M 3/8"</b> <b>MASCHIO CORTO</b> <i>SHORT MP 3/8"</i>	<b>F 1/2"</b> <b>CON GUARNIZIONE</b> <b>INSERTITA</b> <i>INSERTED GASKET</i>	ML 038.150	M 3/8 x F1/2 MM 150	50		2,16
		ML 038.200	M 3/8 x F1/2 MM 200	50		2,27
		ML 038.250	M 3/8 x F1/2 MM 250	50		2,32
		ML 038.300	M 3/8 x F1/2 MM 300	50		2,42
		ML 038.350	M 3/8 x F1/2 MM 350	50		2,53
		ML 038.400	M 3/8 x F1/2 MM 400	50		2,65
		ML 038.450	M 3/8 x F1/2 MM 450	50		2,75
		ML 038.500	M 3/8 x F1/2 MM 500	50		2,85
		ML 038.600	M 3/8 x F1/2 MM 600	10		3,15
		ML 038.800	M 3/8 x F1/2 MM 800	10		3,67
		ML 038.1000	M 3/8 x F1/2 MM 1000	10		3,97

Art. 038

Tubo Flessibile	Treccia INOX	CODICE PRODOTTO	DESCRIZIONE	UDC MINIMA	UNITÀ DI VENDITA	PREZZI EUR <i>escl. IVA</i>
<b>M 1/2"</b>	<b>F 3/8"</b>	LL 019.150	M1/2 x F3/8 MM 150	50		2,22
		LL 019.200	M1/2 x F3/8 MM 200	50		2,33
		LL 019.250	M1/2 x F3/8 MM 250	50		2,38
		LL 019.300	M1/2 x F3/8 MM 300	50		2,47
		LL 019.350	M1/2 x F3/8 MM 350	50		2,58
		LL 019.400	M1/2 x F3/8 MM 400	50		2,63
		LL 019.450	M 1/2 x F3/8 MM 450	50		2,76
		LL 019.500	M1/2 x F3/8 MM 500	50		2,5
		LL 019.600	M1/2 x F3/8 MM 600	10		3,30
		LL 019.800	M1/2 x F3/8 MM 800	10		3,87
		LL 019.1000	M1/2 x F3/8 MM 1000	10		4,10













Art. 019

<b>M 1/2"</b>	<b>F 1/2"</b>	LM 020.150	M1/2 x F1/2 MM 150	50		2,37
		LM 020.200	M1/2 x F1/2 MM 200	50		2,47
		LM 020.250	M1/2 x F1/2 MM 250	50		2,53
		LM 020.300	M1/2 x F1/2 MM 300	50		2,65
		LM 020.350	M1/2 x F1/2 MM 350	50		2,75
		LM 020.400	M1/2 x F1/2 MM 400	50		2,80
		LM 020.450	M1/2 x F1/2 MM 450	50		2,96
		LM 020.500	M1/2 x F1/2 MM 500	50		3,06
		LM 020.600	M1/2 x F1/2 MM 600	10		3,48
		LM 020.800	M1/2 x F1/2 MM 800	10		3,97
		LM 020.1000	M1/2 x F1/2 MM 1000	10		4,25



Art. 020

Tubo Flessibile	Treccia INOX	CODICE PRODOTTO	DESCRIZIONE	UDC MINIMA	UNITÀ DI VENDITA	PREZZI EUR <i>esc. IVA</i>
<b>F 1/2"</b> <b>CON CURVA</b> <i>ELBOW F 1/2"</i>	<b>F 3/8"</b>	MC 021.150	FC 1/2 x F3/8 MM 150	50		2,90
		MC 021.200	FC 1/2 x F3/8 MM 200	50		3,00
		MC 021.250	FC 1/2 x F3/8 MM 250	50		3,15
		MC 021.300	FC 1/2 x F3/8 MM 300	50		3,30
		MC 021.350	FC 1/2 x F3/8 MM 350	50		3,45
		MC 021.400	FC 1/2 x F3/8 MM 400	50		3,60
		MC 021.450	FC 1/2 x F3/8 MM 450	50		3,80
		MC 021.500	FC 1/2 x F3/8 MM 500	50		3,90
		MC 021.600	FC 1/2 x F3/8 MM 600	10		4,15
		MC 021.800	FC 1/2 x F3/8 MM 800	10		4,30
		MC 021.1000	FC 1/2 x F3/8 MM 1000	10		4,60



Art. 021











**F 1/2"**  
**CON CURVA**  
*ELBOW F 1/2"*

**F 1/2"**

<b>F 1/2"</b> <b>CON CURVA</b> <i>ELBOW F 1/2"</i>	<b>F 1/2"</b>	CC 022.150	FC 1/2 x F1/2 MM 150	50		3,00
		CC 022.200	FC 1/2 x F1/2 MM 200	50		3,10
		CC 022.250	FC 1/2 x F1/2 MM 250	50		3,25
		CC 022.300	FC 1/2 x F1/2 MM 300	50		3,45
		CC 022.350	FC 1/2 x F1/2 MM 350	50		3,60
		CC 022.400	FC 1/2 x F1/2 MM 400	50		3,70
		CC 022.450	FC 1/2 x F1/2 MM 450	50		3,85
		CC 022.500	FC 1/2 x F1/2 MM 500	50		3,95
		CC 022.600	FC 1/2 x F1/2 MM 600	10		4,20
		CC 022.800	FC 1/2 x F1/2 MM 800	10		4,35
		CC 022.1000	FC 1/2 x F1/2 MM 1000	10		4,70













Art. 022

Tubo Flessibile	Treccia INOX	CODICE PRODOTTO	DESCRIZIONE	UDC MINIMA	UNITÀ DI VENDITA	PREZZI EUR escl. IVA
<b>M12 x 1 MM 18"</b>	<b>M 1/2"</b>	MV 028.150	M12 x M1/2 MM 150	50		2,33
		MV 028.200	M12 x M1/2 MM 200	50		2,41
		MV 028.250	M12 x M1/2 MM 250	50		2,49
		MV 028.300	M12 x M1/2 MM 300	50		2,63
		MV 028.350	M12 x M1/2 MM 350	50		2,69
		MV 028.400	M12 x M1/2 MM 400	50		2,77
		MV 028.450	M12 x M1/2 MM 450	50		2,95
		MV 028.500	M12 x M1/2 MM 500	50		3,05
		MV 028.600	M12 x M1/2 MM 600	10		3,16
		MV 028.800	M12 x M1/2 MM 800	10		3,46
		MV 028.1000	M12 x M1/2 MM 1000	10		3,77













Art. 028

<b>M12 x 1 MM 18"</b>	<b>F 3/8"</b>	VL 029.150	M12 x F3/8 MM 150	50		2,17
		VL 029.200	M12 x F3/8 MM 200	50		2,28
		VL 029.250	M12 x F3/8 MM 250	50		2,40
		VL 029.300	M12 x F3/8 MM 300	50		2,51
		VL 029.350	M12 x F3/8 MM 350	50		2,63
		VL 029.400	M12 x F3/8 MM 400	50		2,86
		VL 029.450	M12 x F3/8 MM 450	50		2,96
		VL 029.500	M12 x F3/8 MM 500	50		3,09
		VL 029.600	M12 x F3/8 MM 600	10		3,31
		VL 029.800	M12 x F3/8 MM 800	10		3,51
		VL 029.1000	M12 x F3/8 MM 1000	10		3,86













Art. 029

Tubo Flessibile	Treccia INOX	CODICE PRODOTTO	DESCRIZIONE	UDC MINIMA	UNITÀ DI VENDITA	PREZZI EUR escl. IVA
<b>M12 X 1 MM 18"</b>	<b>F 1/2"</b>	VN 030.150	M12 x F1/2 MM 150	50		2,20
		VN 030.200	M12 x F1/2 MM 200	50		2,25
		VN 030.250	M12 x F1/2 MM 250	50		2,32
		VN 030.300	M12 x F1/2 MM 300	50		2,39
		VN 030.350	M12 x F1/2 MM 350	50		2,44
		VN 030.400	M12 x F1/2 MM 400	50		2,60
		VN 030.450	M12 x F1/2 MM 450	50		2,78
		VN 030.500	M12 x F1/2 MM 500	50		2,95
		VN 030.600	M12 x F1/2 MM 600	10		3,05
		VN 030.800	M12 x F1/2 MM 800	10		3,60
		VN 030.1000	M12 x F1/2 MM 1000	10		3,96









Art. 030

<b>M10 X 1 MM 18"</b>	<b>M 1/2"</b>	VR 031.150	M10 x M1/2 MM 150	50		2,23
		VR 031.1200	M10 x M1/2 MM 200	50		2,28
		VR 031.250	M10 x M1/2 MM 250	50		2,33
		VR 031.300	M10 x M1/2 MM 300	50		2,38
		VR 031.350	M10 x M1/2 MM 350	50		2,43
		VR 031.100	M10 x M1/2 MM 400	50		2,49
		VR 031.450	M10 x M1/2 MM 450	50		2,61
		VR 031.500	M10 x M1/2 MM 500	50		2,75
		VR 031.600	M10 x M1/2 MM 600	10		2,95
		VR 031.800	M10 x M1/2 MM 800	10		3,10
		VR 031.1000	M10 x M1/2 MM 1000	10		3,48













Art. 031



Tubo Flessibile	Treccia INOX	CODICE PRODOTTO	DESCRIZIONE	UDC MINIMA	UNITÀ DI VENDITA	PREZZI EUR escl. IVA
<b>M10 x 1 MM 18"</b>	<b>F 3/8"</b>	VS 032.150	M10 x F3/8 MM 150	50		1,90
		VS 032.200	M10 x F3/8 MM 200	50		1,95
		VS 032.250	M10 x F3/8 MM 250	50		2,05
		VS 032.300	M10 x F3/8 MM 300	50		2,10
		VS 032.350	M10 x F3/8 MM 350	50		2,15
		VS 032.400	M10 x F3/8 MM 400	50		2,25
		VS 032.450	M10 x F3/8 MM 450	50		2,37
		VS 032.500	M10 x F3/8 MM 500	50		2,45
		VS 032.600	M10 x F3/8 MM 600	10		2,97
		VS 032.800	M10 x F3/8 MM 800	10		3,15
		VS 032.1000	M10 x F3/8 MM 1000	10		3,35







Art. 032

<b>M10 x 1 MM 18"</b>	<b>F 1/2"</b>	MO 023.150	M10 x F1/2 MM 150	50		1,95
		MO 023.200	M10 x F1/2 MM 200	50		2,00
		MO 023.250	M10 x F1/2 MM 250	50		2,05
		MO 023.300	M10 x F1/2 MM 300	50		2,10
		MO 023.350	M10 x F1/2 MM 350	50		2,19
		MO 023.400	M10 x F1/2 MM 400	50		2,27
		MO 023.450	M10 x F1/2 MM 450	50		2,40
		MO 023.500	M10 x F1/2 MM 500	50		2,65
		MO 023.600	M10 x F1/2 MM 600	10		2,90
		MO 023.800	M10 x F1/2 MM 800	10		3,10
		MO 023.1000	M10 x F1/2 MM 1000	10		3,67











Art. 023

Tubo Flessibile	Treccia INOX	CODICE PRODOTTO	DESCRIZIONE	UDC MINIMA	UNITÀ DI VENDITA	PREZZI EUR escl. IVA
<b>ML10 x 1 MM 45" (6B)</b>	<b>F 3/8"</b>	VO 025.150	ML10 x F3/8 MM 150	50		2,09
		VO 025.200	ML10 x F3/8 MM 200	50		2,19
		VO 025.250	ML10 x F3/8 MM 250	50		2,25
		VO 025.300	ML10 x F3/8 MM 300	50		2,31
		VO 025.350	ML10 x F3/8 MM 350	50		2,41
		VO 025.400	ML10 x F3/8 MM 400	50		2,52
		VO 025.450	ML10 x F3/8 MM 450	50		2,67
		VO 025.500	ML10 x F3/8 MM 500	50		2,87
		VO 025.600	ML10 x F3/8 MM 600	10		3,08
		VO 025.800	ML10 x F3/8 MM 800	10		3,33
		VO 025.1000	ML10 x F3/8 MM 1000	10		3,86













Art. 025

**ML10 MM 45" (6B)**      **F 1/2"**











	FD 026.150	ML10 x F1/2 MM 150	50		2,16
	FD 026.200	ML10 x F1/2 MM 200	50		2,28
	FD 026.250	ML10 x F1/2 MM 250	50		2,38
	FD 026.300	ML10 x F1/2 MM 300	50		2,50
	FD 026.350	ML10 x F1/2 MM 350	50		2,63
	FD 026.400	ML10 x F1/2 MM 400	50		2,74
	FD 026.450	ML10 x F1/2 MM 450	50		2,96
	FD 026.500	ML10 x F1/2 MM 500	50		3,19
	FD 026.600	ML10 x F1/2 MM 600	10		3,41
	FD 026.800	ML10 x F1/2 MM 800	10		3,53
	FD 026.1000	ML10 x F1/2 MM 1000	10		XXX

Art. 026

Tubo Flessibile	Treccia INOX	CODICE PRODOTTO	DESCRIZIONE	UDC MINIMA	UNITÀ DI VENDITA	PREZZI EUR <i>escl. IVA</i>
<b>M10 x 1 MM 18" (6A)</b>	<b>LR ASTINA TUBO LISCIO Ø 10/9.7</b> <i>STRANGHT CONNECTION LR Ø 10/9.7</i>	OO 024.150	M10 x A10 MM 150	50		2,07
		OO 024.200	M10 x A10 MM 200	50		2,18
		OO 024.250	M10 x A10 MM 250	50		2,30
		OO 024.300	M10 x A10 MM 300	50		2,41
		OO 024.350	M10 x A10 MM 350	50		2,53
		OO 024.400	M10 x A10 MM 400	50		2,60
		OO 024.450	M10 x A10 MM 450	50		2,76
		OO 024.500	M10 x A10 MM 500	50		2,89
		OO 024.600	M10 x A10 MM 600	10		3,01
		OO 024.800	M10 x A10 MM 800	10		3,31
		OO 024.1000	M10 x A10 MM 1000	10		3,76













Art. 024

<b>ML10 x 1 MM 45" (6B)</b>	<b>LR ASTINA TUBO LISCIO Ø 10/9.7</b> <i>STRANGHT CONNECTION LR Ø 10/9.7</i>	VL 027.150	ML10 x A10 MM 150	50		2,20
		VL 027.200	ML10 x A10 MM 200	50		2,23
		VL 027.250	ML10 x A10 MM 250	50		2,35
		VL 027.300	ML10 x A10 MM 300	50		2,40
		VL 027.350	ML10 x A10 MM 350	50		2,45
		VL 027.400	ML10 x A10 MM 400	50		2,50
		VL 027.450	ML10 x A10 MM 450	50		2,57
		VL 027.500	ML10 x A10 MM 500	50		2,65
		VL 027.600	ML10 x A10 MM 600	10		2,97
		VL 027.800	ML10 x A10 MM 800	10		3,25
		VL 027.1000	ML10 x A10 MM 1000	10		3,50



Art. 027

Tubo Flessibile	Treccia INOX	CODICE PRODOTTO	DESCRIZIONE	UDC MINIMA	UNITÀ DI VENDITA	PREZZI EUR <i>escl. IVA</i>
<b>M 1/2"</b> <b>MASCHIO PROLUNGATO</b> <b>CON ANELLO PTFE</b> <i>EXTENDED WITH RING M 1/2"</i>	<b>F 3/8"</b> <b>CON GUARNIZIONE</b> <b>INSERITA</b> <i>INSERTED GASKET</i>	VT 033.150	MP 1/2 x F3/8 MM 150	50		2,93
		VT 033.200	MP 1/2 x F3/8 MM 200	50		3,00
		VT 033.250	MP 1/2x F3/8 MM 250	50		3,07
		VT 033.300	MP 1/2x F3/8 MM 300	50		3,14
		VT 033.350	MP 1/2x F3/8 MM 350	50		3,22
		VT 033.400	MP 1/2x F3/8 MM 400	50		3,29
		VT 033.450	MP 1/2x F3/8 MM 450	50		3,40
		VT 033.500	MP 1/2x F3/8 MM 500	50		3,56
		VT 033.600	MP 1/2x F3/8 MM 600	10		3,70
		VT 033.800	MP 1/2x F3/8 MM 800	10		3,80
		VT 033.1000	MP 1/2x F3/8 MM 1000	10		4,07



Art. 033











**M 1/2"**  
**MASCHIO PROLUNGATO**  
**CON ANELLO PTFE**  
*EXTENDED WITH RING M 1/2"*

**F 1/2"**  
**CON GUARNIZIONE**  
**INSERITA**  
*INSERTED GASKET*



Art. 034

VZ 034.150	MP 1/2 x F1/2 MM 150	50		3,10
VZ 034.200	MP 1/2 x F1/2 MM 200	50		3,17
VZ 034.250	MP 1/2 x F1/2 MM 250	50		3,24
VZ 034.300	MP 1/2 x F1/2 MM 300	50		3,31
VZ 034.350	MP 1/2 x F1/2 MM 350	50		3,39
VZ 034.400	MP 1/2 x F1/2 MM 400	50		3,46
VZ 034.450	MP 1/2 x F1/2 MM 450	50		3,57
VZ 034.500	MP 1/2 x F1/2 MM 500	50		3,72
VZ 034.600	MP 1/2 x F1/2 MM 600	10		3,86
VZ 034.800	MP 1/2 x F1/2 MM 800	10		3,96
VZ 034.1000	MP 1/2 x F1/2 MM 1000	10		4,15











Tubo Flessibile	Treccia INOX	CODICE PRODOTTO	DESCRIZIONE	UDC MINIMA	UNITÀ DI VENDITA	PREZZI EUR escl. IVA
<b>MP 1/2"</b> <b>MASCHIO PROLUNGATO CON ANELLO PTFE</b> <i>EXTENDED WITH RING M 1/2"</i>	<b>MB 10</b> <b>MASCHIO BICONO Ø 10 CALOTTA E OGIVA 3 PZ</b> <i>M 3/8 COMPRESSION CONNECT Ø 10 NUT AND RING 3 PCS</i>	VB 035.150	MP 1/2 x MB10 MM 150	50		3,23
		VB 035.200	MP 1/2 x MB10 MM 200	50		3,30
		VB 035.250	MP 1/2x MB10 MM 250	50		3,38
		VB 035.300	MP 1/2x MB10 MM 300	50		3,46
		VB 035.350	MP 1/2x MB10 MM 350	50		3,54
		VB 035.400	MP 1/2x MB10 MM 400	50		4,02
		VB 035.450	MP 1/2x MB10 MM 450	50		4,13
		VB 035.500	MP 1/2x MB10 MM 500	50		4,24
		VB 035.600	MP 1/2x MB10 MM 600	10		4,45
		VB 035.800	MP 1/2x MB10 MM 800	10		4,75
		VB 035.1000	MP 1/2x MB10 MM 1000	10		4,95



Art. 035











**M 3/8"**  
**CON ANELLO PTFE**  
*WITH RING PTFE*

**F 1/2"**

BB 040.150	M 3/8x F1/2 MM 150	50		2,68
BB 040.200	M 3/8 x F1/2 MM 200	50		2,78
BB 040.250	M 3/8 x F1/2 MM 250	50		2,82
BB 040.300	M 3/8 x F1/2 MM 300	50		2,92
BB 040.350	M 3/8 x F1/2 MM 350	50		3,02
BB 040.400	M 3/8 x F1/2 MM 400	50		3,08
BB 040.450	M 3/8 x F1/2 MM 450	50		3,18
BB 040.500	M 3/8 x F1/2 MM 500	50		3,28
BB 040.600	M 3/8 x F1/2 MM 600	10		3,48
BB 040.800	M 3/8 x F1/2 MM 800	10		3,80
BB 040.1000	M 3/8 x F1/2 MM 1000	10		4,03



Art. 040

Tubo Flessibile	Treccia INOX	CODICE PRODOTTO	DESCRIZIONE	UDC MINIMA	UNITÀ DI VENDITA	PREZZI EUR <i>escl. IVA</i>
<b>M 1/2"</b> <b>CON ANELLO PTFE</b> <i>WITH RING PTFE</i>	<b>F 3/8"</b>	BV 041.150	M 1/2 x F3/8 MM 150	50		2,60
		BV 041.200	M 1/2 x F3/8 MM 200	50		2,70
		BV 041.250	M 1/2x F3/8 MM 250	50		2,75
		BV 041.300	M 1/2x F3/8 MM 300	50		2,85
		BV 041.350	M 1/2x F3/8 MM 350	50		2,95
		BV 041.400	M 1/2x F3/8 MM 400	50		3,00
		BV 041.450	M 1/2x F3/8 MM 450	50		3,08
		BV 041.500	M 1/2x F3/8 MM 500	50		3,18
		BV 041.600	M 1/2x F3/8 MM 600	10		3,38
		BV 041.800	M 1/2x F3/8 MM 800	10		3,70
		BV 041.1000	M 1/2x F3/8 MM 1000	10		3,94



Art. 041

<b>M 1/2"</b> <b>CON ANELLO PTFE</b> <i>WITH RING PTFE</i>	<b>M 1/2"</b>	BR 042.150	M 1/2x M1/2 MM 150	50		2,83
		BR 042.200	M 1/2 x M1/2 MM 200	50		2,90
		BR 042.250	M 1/2 x M1/2 MM 250	50		2,97
		BR 042.300	M 1/2 x M1/2 MM 300	50		3,05
		BR 042.350	M 1/2 x M1/2 MM 350	50		3,15
		BR 042.400	M 1/2 x M1/2 MM 400	50		3,23
		BR 042.450	M 1/2 x M1/2 MM 450	50		3,33
		BR 042.500	M 1/2 x M1/2 MM 500	50		3,45
		BR 042.600	M 1/2 x M1/2 MM 600	10		3,59
		BR 042.800	M 1/2 x M1/2 MM 800	10		3,79
		BR 042.1000	M 1/2 x M1/2 MM 1000	10		3,99













Art. 042

Tubo Flessibile	Treccia INOX	CODICE PRODOTTO	DESCRIZIONE	UDC MINIMA	UNITÀ DI VENDITA	PREZZI EUR <i>escl. IVA</i>
<b>M 1/2"</b> CON ANELLO PTFE WITH RING PTFE  	<b>F 3/8"</b> CON GUARNIZIONE INSERITA INSERTED GASKET  	BV 043.150	M1/2 x F3/8 MM 150	50		2,82
		BZ 043.200	M1/2 x F3/8 MM 200	50		2,90
		BZ 043.250	M1/2x F3/8 MM 250	50		2,98
		BZ 043.300	M1/2x F3/8 MM 300	50		3,07
		BZ 043.350	M1/2x F3/8 MM 350	50		3,15
		BZ 043.400	M1/2x F3/8 MM 400	50		3,23
		BZ 043.450	M1/2x F3/8 MM 450	50		3,33
		BZ 043.500	M1/2x F3/8 MM 500	50		3,45
		BZ 043.600	M1/2x F3/8 MM 600	10		3,59
		BZ 043.800	M1/2x F3/8 MM 800	10		3,79
		BZ 043.1000	M1/2x F3/8 MM 1000	10		3,96

Art. 043











<b>M 1/2"</b> CON ANELLO PTFE WITH RING PTFE  	<b>F 1/2"</b> CON GUARNIZIONE INSERITA INSERTED GASKET  	BG 044.150	M1/2 x F1/2 MM 150	50		2,98
		BG 044.200	M1/2 x F1/2 MM 200	50		3,05
		BG 044.250	M1/2 x F1/2 MM 250	50		3,12
		BG 044.300	M1/2 x F1/2 MM 300	50		3,19
		BG 044.350	M1/2 x F1/2 MM 350	50		3,26
		BG 044.400	M1/2 x F1/2 MM 400	50		3,35
		BG 044.450	M1/2 x F1/2 MM 450	50		3,47
		BG 044.500	M1/2 x F1/2 MM 500	50		3,60
		BG 044.600	M1/2 x F1/2 MM 600	10		3,75
		BG 044.800	M1/2 x F1/2 MM 800	10		3,95
		BG 044.1000	M1/2 x F1/2 MM 1000	10		4,20

Art. 044

Tubo Flessibile	Treccia INOX	CODICE PRODOTTO	DESCRIZIONE	UDC MINIMA	UNITÀ DI VENDITA	PREZZI EUR <i>escl. IVA</i>
<b>MB 10</b> <b>MASCHIO BICONE 10 o 12</b> <i>BICONE 10 o 12</i>	<b>M 1/2" o 3/8"</b>	VG 036.150	MB10x M1/2 MM 150	50		3,08
		VG 036.200	MB10x M1/2 MM 200	50		3,18
		VG 036.250	MB10x M1/2 MM 250	50		3,38
		VG 036.300	MB10x M1/2 MM 300	50		3,50
		VG 036.350	MB10x M1/2 MM 350	50		3,63
		VG 036.400	MB10x M1/2 MM 400	50		3,74
		VG 036.450	MB10x M1/2 MM 450	50		3,96
		VG 036.500	MB10x M1/2 MM 500	50		4,19
		VG 036.600	MB10x M1/2 MM 600	10		4,41
		VG 036.800	MB10x M1/2 MM 800	10		4,53
		VG 036.1000	MB10x M1/2 MM 1000	10		4,86



Art. 036

<b>MB 10</b> <b>MASCHIO BICONE 10 o 12</b> <i>BICONE 10 o 12</i>	<b>F 1/2" o 3/8"</b> <b>CON GUARNIZIONE INSERITA</b> <i>INSERTED GASKET</i>	VE 037.150	MB10 x F1/2 MM 150	50		3,05
		VE 037.200	MB10 x F1/2 MM 200	50		3,10
		VE 037.250	MB10 x F1/2 MM 250	50		3,25
		VE 037.300	MB10 x F1/2 MM 300	50		3,30
		VE 037.350	MB10 x F1/2 MM 350	50		3,45
		VE 037.400	MB10 x F1/2 MM 400	50		3,55
		VE 037.450	MB10 x F1/2 MM 450	50		3,67
		VE 037.500	MB10 x F1/2 MM 500	50		3,85
		VE 037.600	MB10 x F1/2 MM 600	10		3,97
		VE 037.800	MB10 x F1/2 MM 800	10		4,25
		VE 037.1000	MB10 x F1/2 MM 1000	10		4,50



Art. 037



# FLESSIBILI DN 10

**FLESSIBILI PER RUBINETTERIA E SANITARI**  
 FLEXIBLES FOR FAUCES AND SANITARIES







DISPONIBILE SU RICHIESTA CON TRECCIA TRICOLORE

## DATI TECNICI - TECHNICAL DATA:

Tubo flessibile trecciato made in Italy in acciaio Inox AISI 304 con interno in gomma alimentare EPDM utilizzato prevalentemente per il collegamento tra la rete idrica e i rubinetti singoli, gli scaldabagni, le pareti doccia attrezzate e le vasche idromassaggio oltre che ai rubinetti posti sulle cucine industriali. Tutti i flessibili sono raccordati con macchine automatiche ed il risultato è l'assoluta precisione di ogni pezzo prodotto per una garanzia di totale qualità.

*Made in Italy braided hose in AISI 304 stainless steel with internal in non-toxic EPDM rubber, mainly used for the connection between the water mains and the single faucet, the boilers, the equipped shower sets and the hydromassage tubs, besides the taps are placed on industrial kitchens. All the hoses are produced with automatic machines and the result is the absolute precision of each produced piece for a total quality guarantee.*

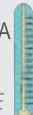









## CARATTERISTICHE - FEATURES:

TEMPERATURA INSTALLAZIONE INSTALLATION TEMPERATURE 	PRESSIONE D'ESERCIZIO WORKING PRESSURE 	PORTATA A 3 BAR FLOW RATE AT 3 BAR 	TEMPERATURA D'IMPIEGO WORKING TEMPERATURE 	FORO MINIMO PASSAGGIO D'ACQUA FITTING INNER DIAMETER 	RAGGIO CURVATURA MINIMO MINIMUM BENDING RADIUS 
da -5°C a +90°C	10 BAR	42 lit/min	-5°C - +90°C	7 mm	35 mm

## MATERIALI - MATERIALS











TUBO HOSE 	Ø INTERNO INNER Ø 10 mm OUTER Ø 14 mm	Treccia 7-8 fili Ø 0,22mm in acciaio Inox AISI 304 Tubo interno: gomma EPDM atossico. 7-8 wires braid Ø 0,22mm in stainless steel Inox AISI 304 Internal pipe: EPDM rubber, atoxic.
RACCORDI FITTINGS 	CW614N CW617N	Ottone CW614N e CW617N nichelato Brass CW614N and CW617N nickel plated
BUSSOLE SLEEVES 	Ø 16 mm	Acciaio Inox AISI 304 Stainless Steel AISI 304



Tubo Flessibile	Treccia INOX	CODICE PRODOTTO	DESCRIZIONE	UDC MINIMA	UNITÀ DI VENDITA	PREZZI EUR <i>escl. IVA</i>
F 1/2"	F 1/2"	FN 005.150	F1/2x F1/2 MM 150	50		1,97
		FN 005.200	F1/2x F1/2 MM 200	50		2,09
		FN 005.250	F1/2x F1/2 MM 250	50		2,22
		FN 005.300	F1/2x F1/2 MM 300	50		2,35
		FN 005.350	F1/2x F1/2 MM 350	50		2,50
		FN 005.400	F1/2x F1/2 MM 400	50		2,65
		FN 005.450	F1/2x F1/2 MM 450	50		2,78
		FN 005.500	F1/2x F1/2 MM 500	50		2,97
		FN 005.600	F1/2x F1/2 MM 600	10		3,17
		FN 005.800	F1/2x F1/2 MM 800	10		3,77
		FN 005.1000	F1/2x F1/2 MM 1000	10		4,12













Art. 005

M 3/8"	F 3/8"	MF 007.150	M3/8 x F3/8 MM 150	50		2,00
		MF 007.200	M3/8 x F3/8 MM 200	50		2,12
		MF 007.250	M3/8 x F3/8. MM 250	50		2,24
		MF 007.300	M3/8 x F3/8 MM 300	50		2,37
		MF 007.350	M3/8 x F3/8 MM 350	50		2,52
		MF 007.400	M3/8 x F3/8 MM 400	50		2,67
		MF 007.450	M3/8 x F3/8 MM 450	50		2,80
		MF 007.500	M3/8 x F3/8 MM 500	50		2,99
		MF 007.600	M3/8 x F3/8 MM 600	10		3,19
		MF 007.800	M3/8 x F3/8 MM 800	10		3,79
		MF 007.1000	M3/8 x F3/8 MM 1000	10		4,14













Art. 007

Tubo Flessibile	Treccia INOX	CODICE PRODOTTO	DESCRIZIONE	UDC MINIMA	UNITÀ DI VENDITA	PREZZI EUR <i>escl. IVA</i>
<b>F 3/8"</b>	<b>F 3/8"</b>	FF 001.150	F3/8x F3/8 MM 150	50		1,93
		FF 001.200	F3/8x F3/8 MM 200	50		2,05
		FF 001.250	F3/8x F3/8 MM 250	50		2,18
		FF 001.300	F3/8x F3/8 MM 300	50		2,31
		FF 001.350	F3/8x F3/8 MM 350	50		2,43
		FF 001.400	F3/8x F3/8 MM 400	50		2,58
		FF 001.450	F3/8x F3/8 MM 450	50		2,71
		FF 001.500	F3/8x F3/8 MM 500	50		2,90
		FF 001.600	F3/8x F3/8 MM 600	10		3,10
		FF 001.800	F3/8x F3/8 MM 800	10		3,70
		FF 001.1000	F3/8x F3/8 MM 1000	10		4,05













Art. 001

<b>F 3/8"</b>	<b>F 1/2"</b>	FR 003.150	F3/8 x F1/2 MM 150	50		1,95
		FR 003.200	F3/8 x F1/2 MM 200	50		2,073
		FR 003.250	F3/8 x F1/2 MM 250	50		2,20
		FR 003.300	F3/8 x F1/2 MM 300	50		2,33
		FR 003.350	F3/8 x F1/2 MM 350	50		2,48
		FR 003.400	F3/8 x F1/2 MM 400	50		2,63
		FR 003.450	F3/8 x F1/2 MM 450	50		2,76
		FR 003.500	F3/8 x F1/2 MM 500	50		2,95
		FR 003.600	F3/8 x F1/2 MM 600	10		3,15
		FR 003.800	F3/8 x F1/2 MM 800	10		3,75
		FR 003.1000	F3/8 x F1/2 MM 1000	10		410













Art. 003

Tubo Flessibile	Treccia INOX	CODICE PRODOTTO	DESCRIZIONE	UDC MINIMA	UNITÀ DI VENDITA	PREZZI EUR escl. IVA
<b>M 3/8"</b>	<b>F 1/2"</b>	MT 301 .150	M3/8 x F1/2 MM 150	50		1,99
		MT 301 .200	M3/8 x F1/2 MM 200	50		2,09
		MT 301 .250	M3/8 x F1/2 MM 250	50		2,24
		MT 301 .300	M3/8 x F1/2 MM 300	50		2,36
		MT 301 .350	M3/8 x F1/2 MM 350	50		2,48
		MT 301 .400	M3/8 x F1/2 MM 400	50		2,60
		MT 301 .450	M3/8 x F1/2 MM 450	50		2,72
		MT 301 .500	M3/8 x F1/2 MM 500	50		2,96
		MT 301 .600	M3/8 x F1/2 MM 600	10		3,24
		MT 301 .800	M3/8 x F1/2 MM 800	10		3,76
		MT 301 .1000	M3/8 x F1/2 MM 1000	10		4,00













Art. 301

<b>M 1/2"</b>	<b>F 3/8"</b>	MZ 321.150	M 1/2 x F3/8 MM 150	50		2,02
		MZ 321.200	M 1/2 x F3/8 MM 200	50		2,11
		MZ 321.250	M 1/2 x F3/8. MM 250	50		2,26
		MZ 321.300	M 1/2 x F3/8 MM 300	50		2,38
		MZ 321.350	M 1/2 x F3/8 MM 350	50		2,50
		MZ 321.400	M 1/2 x F3/8 MM 400	50		2,62
		MZ 321.450	M 1/2 x F3/8 MM 450	50		2,74
		MZ 321.500	M 1/2 x F3/8 MM 500	50		2,98
		MZ 321.600	M 1/2 x F3/8 MM 600	10		3,27
		MZ 321.800	M 1/2 x F3/8 MM 800	10		3,79
		MZ 321.1000	M 1/2 x F3/8 MM 1000	10		4,05















Art. 321

Tubo Flessibile	Treccia INOX	CODICE PRODOTTO	DESCRIZIONE	UDC MINIMA	UNITÀ DI VENDITA	PREZZI EUR <i>escl. IVA</i>
<b>M 1/2"</b>	<b>F 1/2"</b>	ME 311.150	M1/2 x F1/2 MM 150	50		2,04
		ME 311.200	M1/2 x F1/2 MM 200	50		2,13
		ME 311.250	M1/2 x F1/2 MM 250	50		2,28
		ME 311.300	M1/2 x F1/2 MM 300	50		2,40
		ME 311.350	M1/2 x F1/2 MM 350	50		2,52
		ME 311.400	M1/2 x F1/2 MM 400	50		2,64
		ME 311.450	M1/2 x F1/2 MM 450	50		2,76
		ME 311.500	M1/2 x F1/2 MM 500	50		3,00
		ME 311.600	M1/2 x F1/2 MM 600	10		3,29
		ME 311.800	M1/2 x F1/2 MM 800	10		3,83
		ME 311.1000	M1/2 x F1/2 MM 1000	10		4,07



Art. 311

M 3/8"	F 1/2" CON GUARNIZIONE INSERITA INSERTED GASKET				
	CA 421.150	M3/8 x F1/2 MM 150	50		2,19
	CA 421.200	M3/8 x F1/2 MM 200	50		2,26
	CA 421.250	M3/8 x F1/2. MM 250	50		2,34
	CA 421.300	M3/8 x F1/2 MM 300	50		2,44
	CA 421.350	M3/8 x F1/2 MM 350	50		2,55
	CA 421.400	M3/8 x F1/2 MM 400	50		2,65
	CA 421.450	M3/8 x F1/2 MM 450	50		2,85
	CA 421.500	M3/8 x F1/2 MM 500	50		3,05
	CA 421.600	M3/8 x F1/2 MM 600	10		3,25
	CA 421.800	M3/8 x F1/2 MM 800	10		3,30
	CA 421.1000	M3/8 x F1/2 MM 1000	10		3,45

Art. 421

Tubo Flessibile	Treccia INOX	CODICE PRODOTTO	DESCRIZIONE	UDC MINIMA	UNITÀ DI VENDITA	PREZZI EUR <i>escl. IVA</i>
M 1/2"	F 3/8" CON GUARNIZIONE INSERITA INSERTED GASKET	CB 422.150	M1/2 x F3/8 MM 150	50		2,23
		CB 422.200	M1/2 x F3/8 MM 200	50		2,31
		CB 422.250	M1/2 x F3/8 MM 250	50		2,39
		CB 422.300	M1/2 x F3/8 MM 300	50		2,50
		CB 422.350	M1/2 x F3/8 MM 350	50		2,60
		CB 422.400	M1/2 x F3/8 MM 400	50		2,71
		CB 422.450	M1/2 x F3/8 MM 450	50		2,90
		CB 422.500	M1/2 x F3/8 MM 500	50		3,10
		CB 422.600	M1/2 x F3/8 MM 600	10		3,30
		CB 422.800	M1/2 x F3/8 MM 800	10		3,40
		CB 422.1000	M1/2 x F3/8 MM 1000	10		3,60

Art. 422





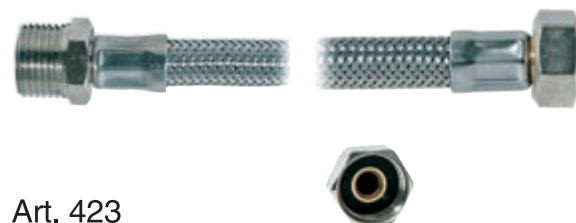





M 1/2"

F 1/2"  
CON GUARNIZIONE  
INSERITA  
INSERTED GASKET



Art. 423

CC 423.150	M1/2 x F1/2 MM 150	50		2,28
CC 423.200	M1/2 x F1/2 MM 200	50		2,33
CC 423.250	M1/2 x F1/2. MM 250	50		2,44
CC 423.300	M1/2 x F1/2 MM 300	50		2,54
CC 423.350	M1/2 x F1/2 MM 350	50		2,65
CC 423.400	M1/2 x F1/2 MM 400	50		2,75
CC 423.450	M1/2 x F1/2 MM 450	50		2,95
CC 423.500	M1/2 x F1/2 MM 500	50		3,15
CC 423.600	M1/2 x F1/2 MM 600	10		3,35
CC 423.800	M1/2 x F1/2 MM 800	10		3,55
CC 423.1000	M1/2 x F1/2 MM 1000	10		3,77

Tubo Flessibile	Treccia INOX	CODICE PRODOTTO	DESCRIZIONE	UDC MINIMA	UNITÀ DI VENDITA	PREZZI EUR <i>escl. IVA</i>
<b>MP 3/8"</b> <b>MASCHIO PROLUNGATO</b> <i>EXTENDED M 3/8"</i>	<b>F 3/8"</b>	MP 201.150	MP 3/8 x F3/8 MM 150	50		2,43
		MP 201.200	MP 3/8 x F3/8 MM 200	50		2,54
		MP 201.250	MP 3/8 x F3/8 MM 250	50		2,67
		MP 201.300	MP 3/8 x F3/8 MM 300	50		2,79
		MP 201.350	MP 3/8 x F3/8 MM 350	50		2,94
		MP 201.400	MP 3/8x F3/8 MM 400	50		3,05
		MP 201.450	MP 3/8 x F3/8 MM 450	50		3,19
		MP 201.500	MP 3/8 x F3/8 MM 500	50		3,39
		MP 201.600	MP 3/8 x F3/8 MM 600	10		3,69
		MP 201.800	MP 3/8 x F3/8 MM 800	10		4,19
		MP 201.1000	MP 3/8 x F3/8 MM 1000	10		4,49













Art. 201

**MP 3/8"**  
**MASCHIO PROLUNGATO**  
*EXTENDED M 3/8"*

**F 1/2"**

	MP 202.150	MP 3/8x F1/2 MM 150	50		2,45
	MP 202.200	MP 3/8x F1/2 MM 200	50		2,56
	MP 202.250	MP 3/8 x F1/2. MM 250	50		2,69
	MP 202.300	MP 3/8x F1/2 MM 300	50		2,81
	MP 202.350	MP 3/8 x F1/2 MM 350	50		2,96
	MP 202.400	MP 3/8 x F1/2 MM 400	50		3,07
	MP 202.450	MP 3/8 x F1/2 MM 450	50		3,21
	MP 202.500	MP 3/8 x F1/2 MM 500	50		3,41
	MP 202.600	MP 3/8 x F1/2 MM 600	10		3,71
	MP 202.800	MP 3/8 x F1/2 MM 800	10		4,21
	MP 202.1000	MP 3/8x F1/2 MM 1000	10		4,51

Art. 202

Tubo Flessibile	Treccia INOX	CODICE PRODOTTO	DESCRIZIONE	UDC MINIMA	UNITÀ DI VENDITA	PREZZI EUR escl. IVA
<b>M 1/2"</b> <b>MASCHIO PROLUNGATO</b> <i>EXTENDED M 1/2"</i>	<b>F 3/8"</b>	MX 204.150	MP 1/2 x F3/8 MM 150	50		2,69
		MX 204.200	MP 1/2x F3/8 MM 200	50		2,82
		MX 204.250	MP 1/2 x F3/8 MM 250	50		2,94
		MX 204.300	MP 1/2x F3/8 MM 300	50		3,07
		MX 204.350	MP 1/2 x F3/8 MM 350	50		3,20
		MX 204.400	MP1/2x F3/8 MM 400	50		3,34
		MX 204.450	MP 1/2x F3/8 MM 450	50		3,47
		MX 204.500	MP 1/2 x F3/8 MM 500	50		3,68
		MX 204.600	MP 1/2x F3/8 MM 600	10		3,93
		MX 204.800	MP 1/2 x F3/8 MM 800	10		4,35
		MX 204.1000	MP 1/2x F3/8 MM 1000	10		4,73



Art. 204

**MP 1/2"**  
**MASCHIO PROLUNGATO**  
*EXTENDED M 1/2"*

**F 1/2"**

		MJ 220.150	MP 1/2x F1/2 MM 150	50		2,73
		MJ 220.200	MP 1/2x F1/2 MM 200	50		2,86
		MJ 220.250	MP 1/2 x F1/2 MM 250	50		2,98
		MJ 220.300	MP 1/2x F1/2 MM 300	50		3,11
		MJ 220.350	MP 1/2 x F1/2 MM 350	50		3,23
		MJ 220.400	MP 1/2 x F1/2 MM 400	50		3,38
		MJ 220.450	MP 1/2 x F1/2 MM 450	50		3,51
		MJ 220.500	MP 1/2 x F1/2 MM 500	50		3,71
		MJ 220.600	MP 1/2 x F1/2 MM 600	10		3,95
		MJ 220.800	MP 1/2 x F1/2 MM 800	10		4,39
		MJ 220.1000	MP 1/2x F1/2 MM 1000	10		4,76

Art. 220



Tubo Flessibile	Treccia INOX	CODICE PRODOTTO	DESCRIZIONE	UDC MINIMA	UNITÀ DI VENDITA	PREZZI EUR escl. IVA
<b>MP 3/8"</b> <b>MASCHIO PROLUNGATO</b> <i>EXTENDED M 3/8"</i>	<b>F 3/8"</b> <b>CON GUARNIZIONE</b> <b>INSERITA</b> <i>INSERTED GASKET</i>	CD 424.150	MP 3/8 x F3/8 MM 150	50		2,45
		CD 424.200	MP 3/8 x F3/8 MM 200	50		2,50
		CD 424.250	MP 3/8 x F3/8 MM 250	50		2,55
		CD 424.300	MP 3/8 x F3/8 MM 300	50		2,65
		CD 424.350	MP 3/8 x F3/8 MM 350	50		2,70
		CD 424.400	MP 3/8x F3/8 MM 400	50		2,75
		CD 424.450	MP 3/8 x F3/8 MM 450	50		2,80
		CD 424.500	MP 3/8 x F3/8 MM 500	50		3,00
		CD 424.600	MP 3/8 x F3/8 MM 600	10		3,20
		CD 424.800	MP 3/8 x F3/8 MM 800	10		3,60
		CD 424.1000	MP 3/8 x F3/8 MM 1000	10		3,80



Art. 424



**MP 1/2"**  
**MASCHIO PROLUNGATO**  
*EXTENDED M 1/2"*











**F 1/2"**  
**CON GUARNIZIONE**  
**INSERITA**  
*INSERTED GASKET*



Art. 425



CE 425.150	MP 1/2x F1/2 MM 150	50		2,50
CE 425.200	MP 1/2x F1/2 MM 200	50		2,55
CE 425.250	MP 1/2 x F1/2Z MM 250	50		2,60
CE 425.300	MP 1/2x F1/2 MM 300	50		2,70
CE 425.350	MP 1/2 x F1/2 MM 350	50		2,75
CE 425.400	MP 1/2 x F1/2 MM 400	50		2,85
CE 425.450	MP 1/2 x F1/2 MM 450	50		2,90
CE 425.500	MP 1/2 x F1/2 MM 500	50		3,05
CE 425.600	MP 1/2 x F1/2 MM 600	10		3,25
CE 425.800	MP 1/2 x F1/2 MM 800	10		3,65
CE 425.1000	MP 1/2x F1/2 MM 1000	10		3,95

Tubo Flessibile	Treccia INOX	CODICE PRODOTTO	DESCRIZIONE	UDC MINIMA	UNITÀ DI VENDITA	PREZZI EUR escl. IVA
<b>MP 3/8"</b> <b>MASCHIO PROLUNGATO</b> <b>CON ANELLO PTFE</b> <i>EXTENDED WITH RING M 3/8"</i>	<b>F 3/8"</b>	MU 388.150	MP 3/8 x F3/8 MM 150	50		2,65
		MU 388.200	MP 3/8 x F3/8 MM 200	50		2,73
		MU 388.250	MP 3/8 x F3/8 MM 250	50		2,80
		MU 388.300	MP 3/8 x F3/8 MM 300	50		2,87
		MU 388.350	MP 3/8 x F3/8 MM 350	50		2,94
		MU 388.400	MP 3/8 x F3/8 MM 400	50		3,03
		MU 388.450	MP 3/8 x F3/8 MM 450	50		3,09
		MU 388.500	MP 3/8 x F3/8 MM 500	50		3,22
		MU 388.600	MP 3/8 x F3/8 MM 600	10		3,40
		MU 388.800	MP 3/8 x F3/8 MM 800	10		3,90
		MU 388.1000	MP 3/8 x F3/8 MM 1000	10		4,30



Art. 388











**MP 1/2"**  
**MASCHIO PROLUNGATO**  
**CON ANELLO PTFE**  
*EXTENDED WITH RING M 1/2"*

**F 1/2"**

<b>MP 1/2"</b> <b>MASCHIO PROLUNGATO</b> <b>CON ANELLO PTFE</b> <i>EXTENDED WITH RING M 1/2"</i>	<b>F 1/2"</b>	MH 389.150	MP 1/2x F1/2 MM 150	50		2,75
		MH 389.200	MP 1/2x F1/2 MM 200	50		2,83
		MH 389.250	MP 1/2 x F1/2 MM 250	50		2,90
		MH 389.300	MP 1/2x F1/2 MM 300	50		2,97
		MH 389.350	MP 1/2 x F1/2 MM 350	50		3,04
		MH 389.400	MP 1/2 x F1/2 MM 400	50		3,13
		MH 389.450	MP 1/2 x F1/2 MM 450	50		3,32
		MH 389.500	MP 1/2 x F1/2 MM 500	50		3,50
		MH 389.600	MP 1/2 x F1/2 MM 600	10		3,70
		MH 389.800	MP 1/2 x F1/2 MM 800	10		4,00
		MH 389.1000	MP 1/2x F1/2 MM 1000	10		4,40



Art. 389

Tubo Flessibile	Treccia INOX	CODICE PRODOTTO	DESCRIZIONE	UDC MINIMA	UNITÀ DI VENDITA	PREZZI EUR <i>escl. IVA</i>
<b>MP 1/2"</b> <b>MASCHIO PROLUNGATO            CON ANELLO PTFE</b> <i>EXTENDED WITH RING M 1/2"</i>	<b>F 3/8"</b>	MY 340.150	MP 1/2 x F3/8 MM 150	50		3,00
		MY 340.200	MP 1/2 x F3/8 MM 200	50		3,07
		MY 340.250	MP 1/2 x F3/8 MM 250	50		3,14
		MY 340.300	MP 1/2 x F3/8 MM 300	50		3,21
		MY 340.350	MP 1/2 x F3/8 MM 350	50		3,28
		MY 340.400	MP 1/2 x F3/8 MM 400	50		3,36
		MY 340.450	MP 1/2 x F3/8 MM 450	50		3,43
		MY 340.500	MP 1/2 x F3/8 MM 500	50		3,54
		MY 340.600	MP 1/2 x F3/8 MM 600	10		3,69
		MY 340.800	MP 1/2 x F3/8 MM 800	10		4,06
		MY 340.1000	MP 1/2 x F3/8 MM 1000	10		4,50



Art. 340

**MP 1/2"**  
**MASCHIO PROLUNGATO  
 CON ANELLO PTFE**  
*EXTENDED WITH RING M 1/2"*

**F 3/8"**  
**CON GUARNIZIONE  
 INSERITA**  
*INSERTED GASKET*

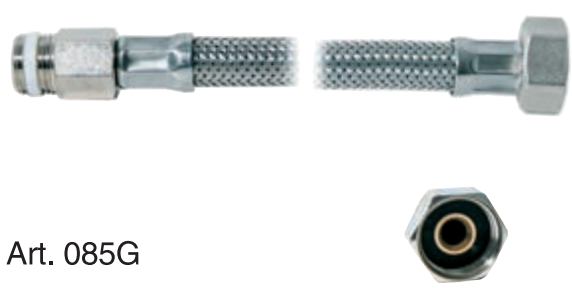

Art. 085G

MG 085.150	MP 1/2 x F3/8 MM 150	50		3,26
MG 085.200	MP 1/2 x F3/8 MM 200	50		3,33
MG 085.250	MP 1/2 x F3/8 MM 250	50		3,38
MG 085.300	MP 1/2 x F3/8 MM 300	50		3,43
MG 085.350	MP 1/2 x F3/8 MM 350	50		3,48
MG 085.400	MP 1/2 x F3/8 MM 400	50		3,64
MG 085.450	MP 1/2 x F3/8 MM 450	50		3,77
MG 085.500	MP 1/2 x F3/8 MM 500	50		3,87
MG 085.600	MP 1/2 x F3/8 MM 600	10		4,07
MG 085.800	MP 1/2 x F3/8 MM 800	10		4,47
MG 085.1000	MP 1/2 x F3/8 MM 1000	10		4,87

Tubo Flessibile	Treccia INOX	CODICE PRODOTTO	DESCRIZIONE	UDC MINIMA	UNITÀ DI VENDITA	PREZZI EUR <i>escl. IVA</i>
<b>MP1/2"</b> <b>MASCHIO PROLUNGATO            CON ANELLO PTFE</b> <i>EXTENDED WITH RING M 1/2"</i>	<b>F 1/2"</b> <b>CON GUARNIZIONE            INSERITA</b> <i>INSERTED GASKET</i>	MP 084.160	MP 1/2 X F1/2 MM 150	50		3,36
		MP 084.200	MP 1/2 X F1/2 MM 200	50		3,41
		MP 084.250	MP 1/2 X F1/2 MM 250	50		3,46
		MP 084.300	MP 1/2 X F1/2 MM 300	50		3,51
		MP 084.350	MP 1/2 X F1/2 MM 350	50		3,67
		MP 084.400	MP 1/2 X F1/2 MM 400	50		3,80
		MP 084.450	MP 1/2 X F1/2 MM 450	50		3,90
		MP 084.500	MP 1/2 X F1/2 MM 500	50		4,10
		MP 084.600	MP 1/2 X F1/2 MM 600	10		4,30
		MP 084.800	MP 1/2 X F1/2 MM 800	10		4,50
		MP 084.1000	MP 1/2 X F1/2 MM 1000	10		4,90

Art. 084G









**M 3/8"**  
**MASCHIO CORTO  
 CON ANELLO PTFE**  
*SHORT WITH RING M 3/8"*

**F 3/8"**



Art. 050

QW 050.150	M 3/8 x F3/8 MM 150	50		2,85
QW 050.200	M 3/8 x F3/8 MM 200	50		2,92
QW 050.250	M 3/8 x F3/8 MM 250	50		2,99
QW 050.300	M 3/8 x F3/8 MM 300	50		3,06
QW 050.350	M 3/8 x F3/8 MM 350	50		3,12
QW 050.400	M 3/8 x F3/8 MM 400	50		3,21
QW 050.450	M 3/8 x F3/8 MM 450	50		3,33
QW 050.500	M 3/8 x F3/8 MM 500	50		3,47
QW 050.600	M 3/8 x F3/8 MM 600	10		3,61
QW 050.800	M 3/8 x F3/8 MM 800	10		3,76
QW 050.1000	M 3/8 x F3/8 MM 1000	10		3,93

Tubo Flessibile	Treccia INOX	CODICE PRODOTTO	DESCRIZIONE	UDC MINIMA	UNITÀ DI VENDITA	PREZZI EUR <i>escl. IVA</i>
<b>M 1/2"</b> <b>MASCHIO</b> <b>CON ANELLO PTFE</b> <i>WITH RING M 1/2"</i>	<b>F1/2"</b>	OR 058.150	M 1/2 x F 1/2 MM 150	50		2,90
		OR 058.200	M 1/2 x F 1/2 MM 200	50		2,97
		OR 058.250	M 1/2 x F 1/2 MM 250	50		3,04
		OR 058.300	M 1/2 x F 1/2 MM 300	50		3,10
		OR 058.350	M 1/2 x F 1/2 MM 350	50		3,18
		OR 058.400	M 1/2 x F 1/2 MM 400	50		3,26
		OR 058.450	M 1/2 x F 1/2 MM 450	50		3,39
		OR 058.500	M 1/2 x F 1/2 MM 500	50		3,52
		OR 058.600	M 1/2 x F 1/2 MM 600	10		3,66
		OR 058.800	M 1/2 x F 1/2 MM 800	10		3,81
		OR 058.1000	M 1/2 x F 1/2 MM 1000	10		3,98







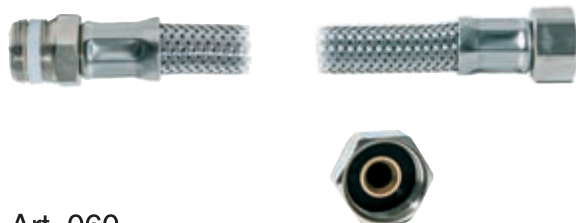



Art. 058

<b>M 1/2"</b> <b>MASCHIO CORTO</b> <b>CON ANELLO PTFE</b> <i>SHORT WITH RING M 3/8"</i>	<b>F 3/8"</b> <b>CON GUARNIZIONE</b> <b>INSERITA</b> <i>INSERTED GASKET</i>	OT 060.150	M 1/2 x F 3/8 MM 150	50		2,98
		OT 060.200	M 1/2 x F 3/8 MM 200	50		3,05
		OT 060.250	M 1/2 x F 3/8 MM 250	50		3,12
		OT 060.300	M 1/2 x F 3/8 MM 300	50		3,17
		OT 060.350	M 1/2 x F 3/8 MM 350	50		3,20
		OT 060.400	M 1/2 x F 3/8 MM 400	50		3,34
		OT 060.450	M 1/2 x F 3/8 MM 450	50		3,45
		OT 060.500	M 1/2 x F 3/8 MM 500	50		3,60
		OT 060.600	M 1/2 x F 3/8 MM 600	10		3,74
		OT 060.800	M 1/2 x F 3/8 MM 800	10		3,89
		OT 060.1000	M 1/2 x F 3/8 MM 1000	10		4,06



Art. 060

Tubo Flessibile	Treccia INOX	CODICE PRODOTTO	DESCRIZIONE	UDC MINIMA	UNITÀ DI VENDITA	PREZZI EUR esc. IVA
<b>M 1/2"</b> <b>MASCHIO CORTO            CON ANELLO PTFE</b> <i>SHORT WITH RING M 1/2"</i>	<b>F 1/2"</b> <b>CON GUARNIZIONE            INSERITA</b> <i>INSERTED GASKET</i>	OV 062.150	M 1/2 x F 1/2 MM 150	50		3,00
		OV 062.200	M 1/2 x F 1/2 MM 200	50		3,07
		OV 062.250	M 1/2 x F 1/2 MM 250	50		3,14
		OV 062.300	M 1/2 x F 1/2 MM 300	50		3,24
		OV 062.350	M 1/2 x F 1/2 MM 350	50		3,38
		OV 062.400	M 1/2 x F 1/2 MM 400	50		3,48
		OV 062.450	M 1/2 x F 1/2 MM 450	50		3,65
		OV 062.500	M 1/2 x F 1/2 MM 500	50		3,89
		OV 062.600	M 1/2 x F 1/2 MM 600	10		3,95
		OV 062.800	M 1/2 x F 1/2 MM 800	10		4,10
		OV 062.1000	M 1/2 x F 1/2 MM 1000	10		4,24

Art. 062





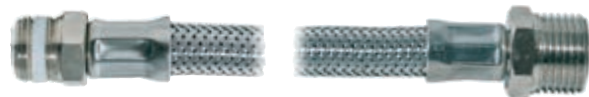





**M 1/2"**  
**MASCHIO CORTO  
 CON ANELLO PTFE**  
*SHORT WITH RING M 1/2"*

**M 1/2"**  
**MASCHIO CORTO**  
*SHORT M 1/2"*



Art. 064

OZ 064.150	M 1/2 x M1/2 MM 150	50		3,09
OZ 064.200	M 1/2 x M1/2 MM 200	50		3,16
OZ 064.250	M 1/2 x M1/2 MM 250	50		3,23
OZ 064.300	M 1/2 x M1/2 MM 300	50		3,31
OZ 064.350	M 1/2 x M1/2 MM 350	50		3,39
OZ 064.400	M 1/2 x M1/2 MM 400	50		3,45
OZ 064.450	M 1/2 x M1/2 MM 450	50		3,53
OZ 064.500	M 1/2 x M1/2 MM 500	50		3,79
OZ 064.600	M 1/2 x M1/2 MM 600	10		3,99
OZ 064.800	M 1/2 x M1/2 MM 800	10		4,16
OZ 064.1000	M 1/2 x M1/2 MM 1000	10		4,60











Tubo Flessibile	Treccia INOX	CODICE PRODOTTO	DESCRIZIONE	UDC MINIMA	UNITÀ DI VENDITA	PREZZI EUR escl. IVA
<b>MP1/2"</b> <b>MASCHIO PROLUNGATO CON ANELLO PTFE</b> <i>EXTENDED WITH RING M 1/2"</i>	<b>MB10</b> <b>MASCHIO BICONE 10 o 12</b> <i>BICONE 10 o 12</i>	MTB 089.150	MP 1/2 x MB10 MM 150	50		3,67
		MTB 089.200	MP 1/2 x MB10 MM 200	50		3,75
		MTB 089.250	MP 1/2 x MB10 MM 250	50		3,83
		MTB 089.300	MP 1/2 x MB10 MM 300	50		3,98
		MTB 089.350	MP 1/2 x MB10 MM 350	50		4,13
		MTB 089.400	MP 1/2 x MB10 MM 400	50		4,26
		MTB 089.450	MP 1/2 x MB10 MM 450	50		4,39
		MTB 089.500	MP 1/2 x MB10 MM 500	50		4,49
		MTB 089.600	MP 1/2 x MB10 MM 600	10		4,78
		MTB 089.800	MP 1/2 x MB10 MM 800	10		5,08
		MTB 089.1000	MP 1/2 x MB10 MM 1000	10		5,49

Art. 089











**MG 1/2"**  
**MASCHIO GIREVOLE**  
*REVOLVING M 1/2"*

**MB10**  
**MASCHIO BICONE 10 o 12**  
*BICONE 10 o 12*













MB 444.150	MG 1/2 x MB10 MM 150	50		3,55
MB 444.200	MG 1/2 x MB10 MM 200	50		3,60
MB 444.250	MG 1/2 x MB10 MM 250	50		3,65
MB 444.300	MG 1/2 x MB10 MM 300	50		3,75
MB 444.350	MG 1/2 x MB10 MM 350	50		3,85
MB 444.400	MG 1/2 x MB10 MM 400	50		3,99
MB 444.450	MG 1/2 x MB10 MM 450	50		4,09
MB 444.500	MG 1/2 x MB10 MM 500	50		4,169
MB 444.600	MG 1/2 x MB10 MM 600	10		4,39
MB 444.800	MG 1/2 x MB10 MM 800	10		4,59
MB 444.1000	MG 1/2 x MB10 MM 1000	10		4,99

Art. 444

Tubo Flessibile	Treccia INOX	CODICE PRODOTTO	DESCRIZIONE	UDC MINIMA	UNITÀ DI VENDITA	PREZZI EUR escl. IVA
<b>MB10</b> MASCHIO BICONE 10 o 12 BICONE 10 o 12	<b>F 3/8" o 1/2"</b>	MTX 083.150	MB10 x F3/8 MM 150	50		3,23
		MTX 083.200	MB10 x F3/8 MM 200	50		3,28
		MTX 083.250	MB10 x F3/8 MM 250	50		3,33
		MTX 083.300	MB10 x F3/8 MM 300	50		3,38
		MTX 083.350	MB10 x F3/8 MM 350	50		3,54
		MTX 083.400	MB10 x F3/8 MM 400	50		3,58
		MTX 083.450	MB10 x F3/8 MM 450	50		3,68
		MTX 083.500	MB10 x F3/8 MM 500	50		3,88
		MTX 083.600	MB10 x F3/8 MM 600	10		3,98
		MTX 083.800	MB10 x F3/8 MM 800	10		4,08
		MTX 083.1000	MB10 x F3/8 MM 1000	10		4,38



Art. 083

<b>MB10</b> MASCHIO BICONE 10 o 12 BICONE 10 o 12	<b>M 1/2" o 3/8"</b>	MTR 081.150	MB10 x M 1/2 MM 150	50		3,28
		MTR 081.200	MB10 x M 1/2 MM 200	50		3,33
		MTR 081.250	MB10 x M 1/2 MM 250	50		3,38
		MTR 081.300	MB10 x M 1/2 MM 300	50		3,43
		MTR 081.350	MB10 x M 1/2 MM 350	50		3,59
		MTR 081.400	MB10 x M 1/2 MM 400	50		3,63
		MTR 081.450	MB10 x M 1/2 MM 450	50		3,73
		MTR 081.500	MB10 x M 1/2 MM 500	50		3,93
		MTR 081.600	MB10 x M 1/2 MM 600	10		4,05
		MTR 081.800	MB10 x M 1/2 MM 800	10		4,16
		MTR 081.1000	MB10 x M 1/2 MM 1000	10		4,48



Art. 081













Tubo Flessibile	Treccia INOX	CODICE PRODOTTO	DESCRIZIONE	UDC MINIMA	UNITÀ DI VENDITA	PREZZI EUR escl. IVA
<b>M 1/2"</b> <b>MASCHIO GIREVOLE</b> <i>REVOLVING M 1/2"</i> 	<b>F 3/8"</b> <b>CON GUARNIZIONE</b> <b>INSERTITA</b> <i>INSERTED GASKET</i>   	MG 502.150	MG 1/2 x F3/8 MM 150	50		3,20
		MG 502.200	MG 1/2 x F3/8 MM 200	50		3,25
		MG 502.250	MG 1/2x F3/8 MM 250	50		3,35
		MG 502.300	MG 1/2x F3/8 MM 300	50		3,45
		MG 502.350	MG 1/2x F3/8 MM 350	50		3,55
		MG 502.400	MG 1/2x F3/8 MM 400	50		3,70
		MG 502.450	MG 1/2x F3/8 MM 450	50		3,85
		MG 502.500	MG 1/2x F3/8 MM 500	50		4,05
		MG 502.600	MG 1/2x F3/8 MM 600	10		4,25
		MG 502.800	MG 1/2x F3/8 MM 800	10		4,45
		MG 502.1000	MG 1/2x F3/8 MM 1000	10		4,67







Art. 502

<b>M 1/2"</b> <b>MASCHIO GIREVOLE</b> <i>REVOLVING M 1/2"</i> 	<b>F 1/2"</b> <b>CON GUARNIZIONE</b> <b>INSERTITA</b> <i>INSERTED GASKET</i>   	MQ 503.150	MG1/2 x F1/2 MM 150	50		3,25
		MQ 503.200	MG1/2 x F1/2 MM 200	50		3,35
		MQ 503.250	MG1/2 x F1/2 MM 250	50		3,45
		MQ 503.300	MG1/2 x F1/2 MM 300	50		3,55
		MQ 503.350	MG1/2 x F1/2 MM 350	50		3,65
		MQ 503.400	MG1/2 x F1/2 MM 400	50		3,75
		MQ 503.450	MG1/2 x F1/2 MM 450	50		3,85
		MQ 503.500	MG1/2 x F1/2 MM 500	50		3,95
		MQ 503.600	MG1/2 x F1/2 MM 600	10		4,35
		MQ 503.800	MG1/2 x F1/2 MM 800	10		4,55
		MQ 503.1000	MG1/2 x F1/2 MM 1000	10		4,75













Art. 503













Tubo Flessibile	Treccia INOX	CODICE PRODOTTO	DESCRIZIONE	UDC MINIMA	UNITÀ DI VENDITA	PREZZI EUR <i>escl. IVA</i>
<b>M 1/2"</b> <b>MASCHIO PROLUNGATO</b> <b>GIREVOLE</b> <i>EXTENDED REVOLVING M 1/2"</i>	<b>F 3/8"</b> <b>CON GUARNIZIONE</b> <b>INSERITA</b> <i>INSERTED GASKET</i>	MW 501.150	MPG 1/2 x F3/8 MM 150	50		3,40
		MW 501.200	MPG 1/2 x F3/8 MM 200	50		3,50
		MW 501.250	MPG 1/2 x F3/8 MM 250	50		3,60
		MW 501.300	MPG 1/2 x F3/8 MM 300	50		3,70
		MW 501.350	MPG 1/2 x F3/8 MM 350	50		3,80
		MW 501.400	MPG 1/2 x F3/8 MM 400	50		3,90
		MW 501.450	MPG 1/2 x F3/8 MM 450	50		4,00
		MW 501.500	MPG 1/2 x F3/8 MM 500	50		4,24
		MW 501.600	MPG 1/2 x F3/8 MM 600	10		4,44
		MW 501.800	MPG 1/2 x F3/8 MM 800	10		4,66
		MW 501.1000	MPG 1/2 x F3/8 MM 1000	10		5,00











Art. 501

<b>M 1/2"</b> <b>MASCHIO PROLUNGATO</b> <b>GIREVOLE</b> <i>EXTENDED REVOLVING M 1/2"</i>	<b>F.1/2"</b> <b>CON GUARNIZIONE</b> <b>INSERITA</b> <i>INSERTED GASKET</i>	MK 511.150	MPG 1/2x F1/2 MM 150	50		3,5
		MK 511.200	MPG 1/2 x F1/2 MM 200	50		3,55
		MK 511.250	MPG 1/2 x F1/2 MM 250	50		3,75
		MK 511.300	MPG 1/2 x F1/2 MM 300	50		3,85
		MK 511.350	MPG 1/2 x F1/2 MM 350	50		3,95
		MK 511.400	MPG 1/2 x F1/2 MM 400	50		4,05
		MK 511.450	MPG 1/2 x F1/2 MM 450	50		4,25
		MK 511.500	MPG 1/2 x F1/2 MM 500	50		4,45
		MK 511.600	MPG 1/2 x F1/2 MM 600	10		4,60
		MK 511.800	MPG 1/2 x F1/2 MM 800	10		4,75
		MK 511.1000	MPG 1/2 x F1/2 MM 1000	10		5,10

Art. 511

Art. 2011	Tubo Flessibile	Treccia INOX	CODICE PRODOTTO	DESCRIZIONE	UDC MINIMA	UNITÀ DI VENDITA	PREZZI EUR escl. IVA
<p><b>F 3/8"</b> CON DADO H15 GUARNIZIONE INSERITA TRECCIA 8 FILI NUT H15 - INSERTED GASKET BRAIDED WIRE</p> 	<p><b>F 3/8"</b> CON DADO H15 GUARNIZIONE INSERITA TRECCIA 8 FILI NUT H15 - INSERTED GASKET BRAIDED WIRE</p> 	DD 2011.150	F 3/8 x F3/8 MM 150	50		2,85	
		DD 2011.200	F 3/8 x F3/8 MM 200	50		2,95	
		DD 2011.250	F 3/8x F3/8 MM 250	50		3,05	
		DD 2011.300	F 3/8x F3/8 MM 300	50		3,15	
		DD 2011.350	F 3/8x F3/8 MM 350	50		3,20	
		DD 2011.400	F 3/8x F3/8 MM 400	50		3,25	
		DD 2011.450	F 3/8x F3/8 MM 450	50		3,30	
		DD 2011.500	F 3/8x F3/8 MM 500	50		3,35	
		DD 2011.600	F 3/8x F3/8 MM 600	10		3,55	
		DD 2011.800	F 3/8x F3/8 MM 800	10		3,78	
		DD 2011.1000	F 3/8x F3/8 MM 1000	10		3,99	

Art. 2012	F 1/2"	F 1/2"				
<p><b>F1/2"</b> CON DADO H15 GUARNIZIONE INSERITA TRECCIA 8 FILI NUT H15 - INSERTED GASKET BRAIDED WIRE</p> 	<p><b>F1/2"</b> CON DADO H15 GUARNIZIONE INSERITA TRECCIA 8 FILI NUT H15 - INSERTED GASKET BRAIDED WIRE</p> 	SS 2012.150	F 1/2 x F1/2 MM 150	50		2,90
		SS 2012.200	F 1/2 x F 1/2 MM 200	50		3,00
		SS 2012.250	F 1/2 x F 1/2 MM 250	50		3,10
		SS 2012.300	F 1/2 x F 1/2 MM 300	50		3,20
		SS 2012.350	F 1/2 x F 1/2 MM 350	50		3,25
		SS 2012.400	F 1/2 x F 1/2 MM 400	50		3,30
		SS 2012.450	F 1/2 x F 1/2 MM 450	50		3,35
		SS 2012.500	F 1/2 x F 1/2 MM 500	50		3,40
		SS 2012.600	F 1/2 x F 1/2 MM 600	10		3,60
		SS 2012.800	F 1/2 x F 1/2 MM 800	10		3,88
		SS 2012.1000	F 1/2 x F 1/2 MM 1000	10		4,09

Tubo Flessibile	Treccia INOX	CODICE PRODOTTO	DESCRIZIONE	UDC MINIMA	UNITÀ DI VENDITA	PREZZI EUR esc. IVA
<b>M 1/2"</b> <b>CORTO</b> SHORT M 1/2"	<b>F 3/8"</b> <b>CON DADO ALTO H15</b> <b>GUARNIZIONE INSERITA</b> <b>TRECCIA 8 FILI</b> NUT H15 - INSERTED GASKET BRAIDED WIRE	SD 2013.150	M1/2 x F3/8 MM 150	50		2,90
		SD 2013.200	M1/2 x F3/8 MM 200	50		2,95
		SD 2013.250	M1/2x F3/8 MM 250	50		3,10
		SD 2013.300	M1/2x F3/8 MM 300	50		3,15
		SD 2013.350	M1/2x F3/8 MM 350	50		3,20
		SD 2013.400	M1/2x F3/8 MM 400	50		3,25
		SD 2013.450	M1/2x F3/8 MM 450	50		3,30
		SD 2013.500	M1/2x F3/8 MM 500	50		3,35
		SD 2013.600	M1/2x F3/8 MM 600	10		3,75
		SD 2013.800	M1/2x F3/8 MM 800	10		3,95
		SD 2013.1000	M1/2x F3/8 MM 1000	10		4,15

Art. 2013





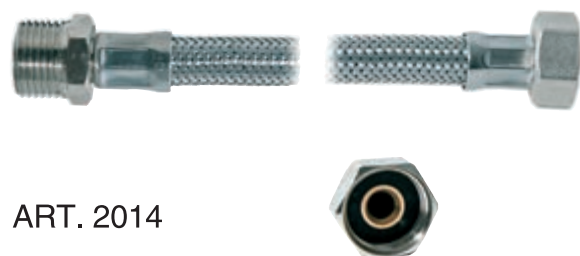





**M 1/2"**  
**CORTO**  
 SHORT M 1/2"

**F 1/2"**  
**CON DADO ALTO H15**  
**GUARNIZIONE INSERITA**  
**TRECCIA 8 FILI**  
 NUT H15 - INSERTED GASKET  
 BRAIDED WIRE



ART. 2014

PR 2014.150	M1/2 x F1/2 MM 150	50		2,95
PR 2014.200	M1/2 x F1/2 MM 200	50		3,00
PR 2014.250	M1/2 x F1/2 MM 250	50		3,15
PR 2014.300	M1/2 x F1/2 MM 300	50		3,20
PR 2014.350	M1/2 x F1/2 MM 350	50		3,25
PR 2014.400	M1/2 x F1/2 MM 400	50		3,30
PR 2014.450	M1/2 x F1/2 MM 450	50		3,35
PR 2014.500	M1/2 x F1/2 MM 500	50		3,40
PR 2014.600	M1/2 x F1/2 MM 600	10		3,80
PR 2014.800	M1/2 x F1/2 MM 800	10		4,00
PR 2014.1000	M1/2 x F1/2 MM 1000	10		4,20

Tubo Flessibile	Treccia INOX	CODICE PRODOTTO	DESCRIZIONE	UDC MINIMA	UNITÀ DI VENDITA	PREZZI EUR escl. IVA
<b>MP 1/2"</b> <b>MASCHIO PROLUNGATO</b> <i>EXTENDED M 1/2"</i>	<b>F 3/8"</b> <b>CON DADO ALTO H15</b> <b>GUARNIZIONE INSERITA</b> <b>TRECCIA 8 FILI</b> <i>NUT H15 - INSERTED GASKET</i> <i>BRAIDED WIRE</i>	MI 2015.150	MP 1/2 x F3/8 MM 150	50		3,30
		MI 2015.200	MP 1/2 x F3/8 MM 200	50		3,35
		MI 2015.250	MP 1/2 x F3/8 MM 250	50		3,40
		MI 2015.300	MP 1/2 x F3/8 MM 300	50		3,45
		MI 2015.350	MP 1/2 x F3/8 MM 350	50		3,50
		MI 2015.400	MP 1/2 x F3/8 MM 400	50		3,55
		MI 2015.450	MP 1/2 x F3/8 MM 450	50		3,60
		MI 2015.500	MP 1/2 x F3/8 MM 500	50		3,65
		MI 2015.600	MP 1/2 x F3/8 MM 600	10		3,75
		MI 2015.800	MP 1/2 x F3/8 MM 800	10		3,95
		MI 2015.1000	MP 1/2 x F3/8 MM 1000	10		4,15

Art. 2015

**MP 1/2"**  
**MASCHIO PROLUNGATO**  
*EXTENDED M 1/2"*















**F 1/2"**  
**CON DADO ALTO H15**  
**GUARNIZIONE INSERITA**  
**TRECCIA 8 FILI**  
*NUT H15 - INSERTED GASKET*  
*BRAIDED WIRE*



Art. 2016

VA 2016.150	MP 1/2 x F1/2 MM 150	50		3,35
VA 2016.200	MP 1/2 x F1/2 MM 200	50		3,40
VA 2016.250	MP 1/2 x F1/2 MM 250	50		3,45
VA 2016.300	MP 1/2 x F1/2 MM 300	50		3,50
VA 2016.350	MP 1/2 x F1/2 MM 350	50		3,55
VA 2016.400	MP 1/2 x F1/2 MM 400	50		3,60
VA 2016.450	MP 1/2 x F1/2 MM 450	50		3,65
VA 2016.500	MP 1/2 x F1/2 MM 500	50		3,70
VA 2016.600	MP 1/2 x F1/2 MM 600	10		3,80
VA 2016.800	MP 1/2 x F1/2 MM 800	10		4,00
VA 2016.1000	MP 1/2 x F1/2 MM 1000	10		4,20

Art. 2017	Tubo Flessibile	Treccia INOX	CODICE PRODOTTO	DESCRIZIONE	UDC MINIMA	UNITÀ DI VENDITA	PREZZI EUR escl. IVA
<b>MP 1/2"</b> <b>MASCHIO PROLUNGATO</b> <b>CON ANELLO PTFE</b> <i>EXTENDED WITH RING M 1/2"</i> 	<b>F 3/8"</b> <b>CON DADO ALTO H15</b> <b>GUARNIZIONE INSERITA</b> <b>TRECCIA 8 FILI</b> <i>NUT H15 - INSERTED GASKET</i> <i>BRAIDED WIRE</i>   	VP 2017.150	MP 1/2 x F 3/8 MM 150	50		4,13	
		VP 2017.200	MP 1/2 x F 3/8 MM 200	50		4,18	
		VP 2017.250	MP 1/2 x F 3/8 MM 250	50		4,23	
		VP 2017.300	MP 1/2 x F 3/8 MM 300	50		4,28	
		VP 2017.350	MP 1/2 x F 3/8 MM 350	50		4,33	
		VP 2017.400	MP 1/2 x F 3/8 MM 400	50		4,38	
		VP 2017.450	MP 1/2 x F 3/8 MM 450	50		4,43	
		VP 2017.500	MP 1/2 x F 3/8 MM 500	50		4,98	
		VP 2017.600	MP 1/2 x F 3/8 MM 600	10		4,55	
		VP 2017.800	MP 1/2 x F 3/8 MM 800	10		4,65	
		VP 2017.1000	MP 1/2 x F 3/8 MM 1000	10		4,85	

Art. 2018	MP 1/2"	F 1/2"				
<b>MP 1/2"</b> <b>MASCHIO PROLUNGATO</b> <b>CON ANELLO PTFE</b> <i>EXTENDED WITH RING M 1/2"</i> 	<b>F 1/2"</b> <b>CON DADO ALTO H15</b> <b>GUARNIZIONE INSERITA</b> <b>TRECCIA 8 FILI</b> <i>NUT H15 - INSERTED GASKET</i> <i>BRAIDED WIRE</i>   	BT 2018.150	MP 1/2 x F1/2 MM 150	50		4,18
		BT 2018.200	MP 1/2 x F1/2 MM 200	50		4,23
		BT 2018.250	MP 1/2 x F1/2 MM 250	50		4,28
		BT 2018.300	MP 1/2 x F1/2 MM 300	50		4,33
		BT 2018.350	MP 1/2 x F1/2 MM 350	50		4,38
		BT 2018.400	MP 1/2 x F1/2 MM 400	50		4,43
		BT 2018.450	MP 1/2 x F1/2 MM 450	50		4,48
		BT 2018.500	MP 1/2 x F1/2 MM 500	50		4,55
		BT 2018.600	MP 1/2 x F1/2 MM 600	10		4,70
		BT 2018.800	MP 1/2 x F1/2 MM 800	10		4,75
		BT 2018.1000	MP 1/2 x F1/2 MM 1000	10		4,95

**FLESSIBILI PER SCALDABAGNO, CALDAIE ED ELETTRODOMESTICI**  
 FLEXIBLES HOSES FOR WATER HEATERS, BOILERS AND HOUSEOLD APPLIANCES

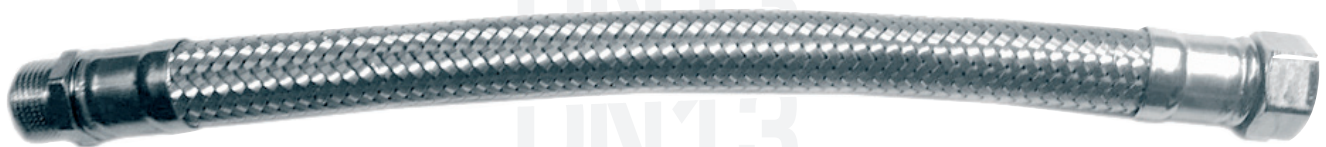







DISPONIBILE SU RICHIESTA CON TRECCIA TRICOLORE

## DATI TECNICI - TECHNICAL DATA:



Tubo flessibile trecciato made in Italy in acciaio Inox AISI 304 con interno in gomma alimentare EPDM utilizzato prevalentemente per il collegamento tra la rete idrica e i rubinetti singoli, gli scaldabagni, le pareti doccia attrezzate e le vasche idromassaggio oltre che ai rubinetti posti sulle cucine industriali. Tutti i flessibili sono raccordati con macchine automatiche ed il risultato e' l'assoluta precisione di ogni pezzo prodotto per una garanzia di totale qualità.

*Made in Italy braided hose in AISI 304 stainless steel with internal in non-toxic EPDM rubber, mainly used for the connection between the water mains and the single faucet, the boilers, the equipped shower sets and the hydromassage tubs, besides the taps are placed on industrial kitchens. All the hoses are produced with automatic machines and the result is the absolute precision of each produced piece for a total quality guarantee.*





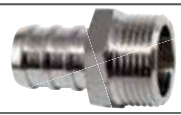





## CARATTERISTICHE - FEATURES:

<b>TEMPERATURA INSTALLAZIONE</b> <small>INSTALLATION TEMPERATURE</small> 	<b>PRESSIONE D'ESERCIZIO</b> <small>WORKING PRESSURE</small> 	<b>PORTATA A 3 BAR</b> <small>FLOW RATE AT 3 BAR</small> 	<b>TEMPERATURA D'IMPIEGO</b> <small>WORKING TEMPERATURE</small> 	<b>FORO MINIMO PASSAGGIO D'ACQUA</b> <small>FITTING INNER DIAMETER</small> 	<b>RAGGIO CURVATURA MINIMO</b> <small>MINIMUM BENDING RADIUS</small> 
da -5°C a +90°C	16 BAR	65 lit/min	-5°C - +90°C	9,3 mm	45 mm

## MATERIALI - MATERIALS











<b>TUBO</b> <small>HOSE</small> 	<b>Ø INTERNO</b> <small>INNER Ø</small> 13 mm	<b>Ø ESTERNO</b> <small>OUTER Ø</small> 18 mm	Treccia 9 fili Ø 0,22mm in acciaio Inox AISI 304 Tubo interno: gomma EPDM atossico. 9 wires braid Ø 0,22mm in stainless steel Inox AISI 304 Internal pipe: EPDM rubber, atoxic.
<b>RACCORDI</b> <small>FITTINGS</small> 	CW614N CW617N		Ottone CW614N CW617N nichelato o giallo Brass CW617N nickel plated or yellow
<b>BUSSOLE</b> <small>SLEEVES</small> 	Ø 20 mm		Acciaio Inox AISI 304 Stainless steel AISI 304



Tubo Flessibile	Treccia INOX	CODICE PRODOTTO	DESCRIZIONE	UDC MINIMA	UNITÀ DI VENDITA	PREZZI EUR <i>escl. IVA</i>
<b>F 1/2"</b>	<b>F 1/2"</b>	GC 313.150	F1/2x F1/2 MM 150	50		3,05
		GC 313.200	F1/2x F1/2 MM 200	50		3,26
		GC 313.250	F1/2x F1/2 MM 250	50		3,48
		GC 313.300	F1/2x F1/2 MM 300	50		3,78
		GC 313.350	F1/2x F1/2 MM 350	50		3,92
		GC 313.400	F1/2x F1/2 MM 400	50		4,13
		GC 313.450	F1/2x F1/2 MM 450	50		4,57
		GC 313.500	F1/2x F1/2 MM 500	50		4,98
		GC 313.600	F1/2x F1/2 MM 600	10		5,40
		GC 313.800	F1/2x F1/2 MM 800	10		5,81
		GC 313.1000	F1/2x F1/2 MM 1000	10		6,37







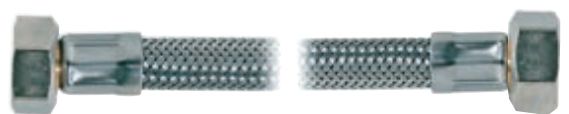





Art. 313

<b>F 1/2"</b>	<b>F 3/4"</b>	GD 314.150	F 1/2 x F 3/4 MM 150	50		3,30
		GD 314.200	F 1/2 x F 3/4 MM 200	50		3,52
		GD 314.250	F 1/2 x F 3/4. MM 250	50		3,73
		GD 314.300	F 1/2 x F 3/4 MM 300	50		3,98
		GD 314.350	F 1/2 x F 3/4 MM 350	50		4,12
		GD 314.400	F 1/2 x F 3/4 MM 400	50		4,38
		GD 314.450	F 1/2 x F 3/4 MM 450	50		4,83
		GD 314.500	F 1/2 x F 3/4 MM 500	50		5,24
		GD 314.600	F 1/2 x F 3/4 MM 600	10		5,65
		GD 314.800	F 1/2 x F 3/4 MM 800	10		6,09
		GD 314.1000	F 1/2 x F 3/4 MM 1000	10		6,62













Art. 314













Tubo Flessibile	Treccia INOX	CODICE PRODOTTO	DESCRIZIONE	UDC MINIMA	UNITÀ DI VENDITA	PREZZI EUR <i>escl. IVA</i>
<b>F 3/4"</b>	<b>F 3/4"</b>	GS 316.150	F 3/4 x F 3/4 MM 150	50		3,94
		GS 316.200	F 3/4 x F 3/4 MM 200	50		4,15
		GS 316.250	F 3/4 x F 3/4 MM 250	50		4,37
		GS 316.300	F 3/4 x F 3/4 MM 300	50		4,59
		GS 316.350	F 3/4 x F 3/4 MM 350	50		4,82
		GS 316.400	F 3/4 x F 3/4 MM 400	50		5,03
		GS 316.450	F 3/4 x F 3/4 MM 450	50		5,55
		GS 316.500	F 3/4 x F 3/4 MM 500	50		5,87
		GS 316.600	F 3/4 x F 3/4 MM 600	10		6,35
		GS 316.800	F 3/4 x F 3/4 MM 800	10		6,67
		GS 316.1000	F 3/4 x F 3/4 MM 1000	10		7,25

Art. 316

<b>M 3/4"</b>	<b>F 3/4"</b>	GM 318.150	M 3/4 x F 3/4 MM 150	50		4,26
		GM 318.200	M 3/4 x F 3/4 MM 200	50		4,48
		GM 318.250	M 3/4 x F 3/4. MM 250	50		4,70
		GM 318.300	M 3/4 x F 3/4 MM 300	50		4,92
		GM 318.350	M 3/4 x F 3/4 MM 350	50		5,35
		GM 318.400	M 3/4 x F 3/4 MM 400	50		5,80
		GM 318.450	M 3/4 x F 3/4 MM 450	50		6,30
		GM 318.500	M 3/4 x F 3/4 MM 500	50		6,75
		GM 318.600	M 3/4 x F 3/4 MM 600	10		7,18
		GM 318.800	M 3/4 x F 3/4 MM 800	10		7,75
		GM 318.1000	M 3/4 x F 3/4 MM 1000	10		7,95

Art. 318

Tubo Flessibile	Treccia INOX	CODICE PRODOTTO	DESCRIZIONE	UDC MINIMA	UNITÀ DI VENDITA	PREZZI EUR <i>escl. IVA</i>
<b>M 1/2"</b> <b>MASCHIO CORTO</b> <i>SHORT M 1/2"</i>	<b>F1/2"</b>	GR 322.150	M1/2 x F1/2 MM 150	50		3,08
		GR 322.200	M1/2 x F1/2 MM 200	50		3,29
		GR 322.250	M1/2 x F1/2 MM 250	50		3,55
		GR 322.300	M1/2 x F1/2 MM 300	50		3,79
		GR 322.350	M1/2 x F1/2 MM 350	50		3,98
		GR 322.400	M1/2 x F1/2 MM 400	50		4,18
		GR 322.450	M1/2 x F1/2 MM 450	50		4,62
		GR 322.500	M1/2 x F1/2 MM 500	50		5,02
		GR 322.600	M1/2 x F1/2 MM 600	10		5,45
		GR 322.800	M1/2 x F1/2 MM 800	10		5,95
		GR 322.1000	M1/2 x F1/2 MM 1000	10		6,56











Art. 322

**M1/2"**  
**MASCHIO CORTO**  
*SHORT M 1/2"*

**F 3/4"**

	GT 324.150	M1/2 x F3/4 MM 150	50		3,33
	GT 324.200	M1/2 x F3/4 MM 200	50		3,55
	GT 324.250	M1/2 x F3/4 MM 250	50		3,78
	GT 324.300	M1/2 x F3/4 MM 300	50		4,05
	GT 324.350	M1/2 x F3/4 MM 350	50		4,24
	GT 324.400	M1/2 x F3/4 MM 400	50		4,45
	GT 324.450	M1/2 x F3/4 MM 450	50		4,93
	GT 324.500	M1/2 x F3/4 MM 500	50		5,28
	GT 324.600	M1/2 x 3/4 MM 600	10		5,88
	GT 324.800	M1/2 x 3/4 MM 800	10		6,21
	GT 324.1000	M1/2 x F3/4 MM 1000	10		6,85

Art. 324

Tubo Flessibile	Treccia INOX	CODICE PRODOTTO	DESCRIZIONE	UDC MINIMA	UNITÀ DI VENDITA	PREZZI EUR <i>esc. IVA</i>
<b>M 1/2"</b> <b>MASCHIO PROLUNGATO</b> <i>EXTENDED M 1/2"</i>	<b>F 1/2"</b>	GP 326.150	MP 1/2 x F1/2 MM 150	50		4,12
		GP 326.200	MP 1/2 x F1/2 MM 200	50		4,23
		GP 326.250	MP 1/2 x F1/2 MM 250	50		4,39
		GP 326.300	MP 1/2 x F1/2 MM 300	50		4,49
		GP 326.350	MP 1/2 x F1/2 MM 350	50		4,63
		GP 326.400	MP 1/2 x F1/2 MM 400	50		4,75
		GP 326.450	MP 1/2 x F1/2 MM 450	50		4,96
		GP 326.500	MP 1/2 x F1/2 MM 500	50		5,23
		GP 326.600	MP 1/2 x F1/2 MM 600	10		5,46
		GP 326.800	MP 1/2 x F1/2 MM 800	10		5,85
		GP 326.1000	MP 1/2 x F1/2 MM 1000	10		5,98



Art. 326











**M 1/2"**  
**MASCHIO PROLUNGATO**  
*EXTENDED M 1/2"*

**F 3/4"**

<b>M 1/2"</b> <b>MASCHIO PROLUNGATO</b> <i>EXTENDED M 1/2"</i>	<b>F 3/4"</b>	GZ 340.150	MP 1/2 x F3/4 MM 150	50		4,45
		GZ 340.200	MP 1/2 x F3/4 MM 200	50		4,67
		GZ 340.250	MP 1/2 x F3/4 MM 250	50		4,90
		GZ 340.300	MP 1/2 x F3/4 MM 300	50		5,05
		GZ 340.350	MP 1/2 x F3/4 MM 350	50		5,10
		GZ 340.400	MP 1/2 x F3/4 MM 400	50		5,38
		GZ 340.450	MP 1/2 x F3/4 MM 450	50		5,58
		GZ 340.500	MP 1/2 x F3/4 MM 500	50		5,78
		GZ 340.600	MP 1/2 x F3/4 MM 600	10		5,98
		GZ 340.800	MP 1/2 x F3/4 MM 800	10		6,07
		GZ 340.1000	MP 1/2 x F3/4 MM 1000	10		6,32













Art. 340

Tubo Flessibile	Treccia INOX	CODICE PRODOTTO	DESCRIZIONE	UDC MINIMA	UNITÀ DI VENDITA	PREZZI EUR <i>escl. IVA</i>
<b>F 1/2"</b>	<b>F 3/4" o 1/2"</b> <b>CURVA</b> <i>ELBOW F 3/4" o 1/2"</i>	GC 328.150	F1/2 x FC 3/4 MM 150	50		4,84
		GC 328.200	F1/2 x FC 3/4 MM 200	50		5,05
		GC 328.250	F1/2 x FC 3/4 MM 250	50		5,26
		GC 328.300	F1/2 x FC 3/4 MM 300	50		5,51
		GC 328.350	F1/2 x FC 3/4 MM 350	50		5,70
		GC 328400	F1/2 x FC 3/4 MM 400	50		5,92
		GC 328.450	F1/2 x FC 3/4 MM 450	50		6,36
		GC 328.500	F1/2 x FC 3/4 MM 500	50		6,76
		GC 328.600	F1/2 x FC 3/4 MM 600	10		719
		GC 328.800	F1/2 x FC 3/4 MM 800	10		7,60
		GC 328.1000	F1/2 x FC 3/4 MM 1000	10		8,15



Art. 328

<b>F 3/4"</b>	<b>F 3/4"</b> <b>CURVA</b> <i>ELBOW F 3/4"</i>	GF 330.150	F3/4 x FC 3/4 MM 150	50		5,06
		GF 330.200	F3/4 x FC 3/4 MM 200	50		5,26
		GF 330.250	F3/4 x FC 3/4 MM 250	50		5,48
		GF 330.300	F3/4 x FC 3/4 MM 300	50		5,70
		GF 330.350	F3/4 x FC 3/4 MM 350	50		5,90
		GF 330.400	F3/4 x FC 3/4 MM 400	50		6,12
		GF 330.450	F3/4 x FC 3/4 MM 450	50		6,56
		GF 330.500	F3/4 x FC 3/4 MM 500	50		7,00
		GF 330.600	F3/4 x FC 3/4 MM 600	10		7,43
		GF 330.800	F3/4 x FC 3/4 MM 800	10		7,86
		GF 330.1000	F3/4 x FC 3/4 MM 1000	10		8,84



Art. 330

# FLESSIBILI ANTIVIBRANTI

ANTIVIBRATION FLEXIBLES



## DATI TECNICI - TECHNICAL DATA:

Flessibili antivibranti made in Italy rivestiti con treccia in Acciaio Zincato ed interno in tubo in gomma alimentare EPDM utilizzati per il collegamento tra la rete idrica e pompe, caldaie, autoclavi e depuratori, sono disponibili nelle misure da 1/2" fino a 2". Tutti i flessibili sono raccordati con macchine automatiche ed il risultato è l'assoluta precisione di ogni pezzo prodotto per una garanzia di totale qualità.

*Made in Italy anti-vibration flexible hoses, galvanized steel braided, with internal in non-toxic EPDM rubber, used for the connection between the water mains and pumps, boilers, autoclaves and water conditioner; available from 1/2" to 2" size. All the hoses are connected with automatic machines and the result is the absolute precision of each produced piece for a total quality guarantee.*



# FLESSIBILI ANTIVIBRANTI



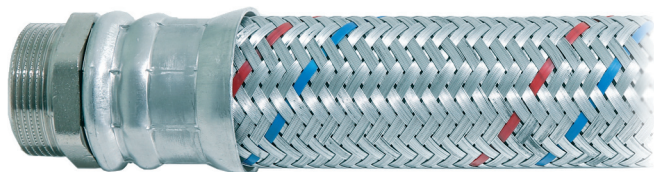

ANTIVIBRATION FLEXIBLES





**FLESSIBILE ANTIVIBRANTE**  
**1/2 - 3/4 - 1" - 1"1/4 - 1"1/2 - 2"**  
**TRECCIATO CON FILO**  
**DI ACCIAIO ZINCATO**  
**ATTACCHI DIRITTI**







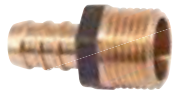



*FLEXIBLE ANTIVIBRANTE*  
*1/2 - 3/4 - 1" - 1"1/4 - 1"1/2 - 2"*  
*COVERED WITH BRAID OF THREAD*  
*IN GALVANIZED STEEL*  
*STRAIGHT CONNECTIONS*

## CARATTERISTICHE - FEATURES:

	PRESSIONE D'ESERCIZIO WORKING PRESSURE 	PORTATA A 3 BAR FLOW RATE AT 3 BAR 	TEMPERATURA D'IMPIEGO WORKING TEMPERATURE 	FORO MINIMO PASSAGGIO D'ACQUA FITTING INNER DIAMETER 	RAGGIO CURVATURA MINIMO MINIMUM BENDING RADIUS 
Tubo Dn13 - 1/2"	15 BAR	120 lit/min	-10°C - +90°C	9,3 mm	60 mm
Tubo Dn19 - 3/4"	15 BAR	120 lit/min	-10°C - +90°C	15 mm	70 mm
Tubo Dn25 - 1"	15 BAR	200 lit/min	-10°C - +90°C	20 mm	100 mm
Tubo Dn32 - 1 1/4"	10 BAR	450 lit/min	-10°C - +90°C	26 mm	190 mm
Tubo Dn40 - 1 1/2"	10 BAR	700 lit/min	-10°C - +90°C	32 mm	180 mm
Tubo Dn50 - 2"	10 BAR	900 lit/min	-10°C - +90°C	41 mm	300 mm











## MATERIALI - MATERIALS

TUBO HOSE		Ø INTERNO INNER Ø	Ø ESTERNO OUTER Ø	Treccia Ø 0,30mm in Acciaio Zincato Tubo interno: gomma EPDM atossico. <i>wires braid Ø 0,30mm in steel galvanized</i> <i>Internal pipe: EPDM rubber, atoxic.</i>
	Tubo Dn13 - 1/2"	13 mm	19 mm	
	Tubo Dn19 - 3/4"	19 mm	27 mm	
	Tubo Dn25 - 1"	25 mm	33 mm	
	Tubo Dn32 - 1 1/4"	30 mm	42 mm	
	Tubo Dn40 - 1 1/2"	40 mm	52 mm	
Tubo Dn50 - 2"	50 mm	62 mm		
RACCORDI FITTINGS		CW614N CW617N		Ottone CW614N e CW617N giallo o nichelato <i>Brass CW614N and CW617N yellow or nickel plated</i>
BUSSOLE SLEEVES		Alluminio 99,5% <i>Aluminium 99,5%</i>		

Tubo Flessibile	Treccia INOX	CODICE PRODOTTO	DESCRIZIONE	UDC MINIMA	UNITÀ DI VENDITA	PREZZI EUR <i>escl. IVA</i>
<b>M 1/2"</b>	<b>F 1/2"</b>	AV 106.300	M 1/2 x F1/2 MM 300	10		4,55
		AV 106.350	M 1/2 x F1/2 MM 350	10		4,88
		AV 106.400	M 1/2 x F1/2 MM 400	10		5,30
		AV 106.450	M 1/2 x F1/2 MM 450	10		5,80
		AV 106.500	M 1/2 x F1/2 MM 500	10		6,30
		AV 106.600	M 1/2 x F1/2 MM 600	10		6,80
		AV 106.700	M 1/2 x F1/2 MM 700	10		7,25
		AV 106.800	M 1/2 x F1/2 MM 800	10		7,80
		AV 106.900	M 1/2 x F1/2 MM 900	10		9,30
		AV 106.1000	M 1/2 x F1/2 MM 1000	10		9,80













Art. 106

<b>M 3/4"</b>	<b>F 3/4"</b>	AN 108.300	M 3/4 x F 3/4 MM 300	10		6,80
		AN 108.350	M 3/4 x F 3/4 MM 350	10		7,15
		AN 108.400	M 3/4 x F 3/4 MM 400	10		7,55
		AN 108.450	M 3/4 x F 3/4 MM 450	10		8,05
		AN 108.500	M 3/4 x F 3/4 MM 500	10		8,55
		AN 108.600	M 3/4 x F 3/4 MM 600	10		9,15
		AN 108.700	M 3/4 x F 3/4 MM 700	10		9,65
		AN 108.800	M 3/4 x F 3/4 MM 800	10		10,25
		AN 108.900	M 3/4 x F 3/4 MM 900	10		10,75
		AN 108.1000	M 3/4 x F 3/4 MM 1000	10		11,15













Art. 108

Tubo Flessibile	Treccia INOX	CODICE PRODOTTO	DESCRIZIONE	UDC MINIMA	UNITÀ DI VENDITA	PREZZI EUR escl. IVA
<b>M 1"</b>	<b>F 1"</b>	AT 110.300	M1" x F1" MM 300	10		10,75
		AT 110.350	M1" x F1" MM 350	10		11,00
		AT 110.400	M1" x F1" MM 400	10		11,45
		AT 110.450	M1" x F1" MM 450	10		11,90
		AT 110.500	M1" x F1" MM 500	10		12,45
		AT 110.600	M1" x F1" MM 600	10		13,55
		AT 110.700	M1" x F1" MM 700	10		15,94
		AT 110.800	M1" x F1" MM 800	5		16,95
		AT 110.900	M1" x F1" MM 900	5		18,00
		AT 110.1000	M1" x F1" MM 1000	5		18,55







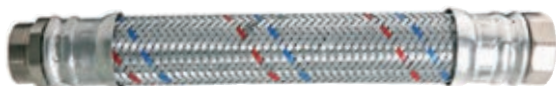





Art. 110

<b>M 1"1/4</b>	<b>F 1"1/4</b>	AS 112.300	M1"1/4 x F1"1/4 MM 300	10		20,20
		AS 112.350	M1"1/4 x F1"1/4 MM 350	10		21,16
		AS 112.400	M1"1/4 x F1"1/4 MM 400	10		22,18
		AS 112.450	M1"1/4 x F1"1/4 MM 450	10		23,19
		AS 112.500	M1"1/4 x F1"1/4 MM 500	10		24,12
		AS 112.600	M1"1/4 x F1"1/4 MM 600	10		26,15
		AS 112.700	M1"1/4 x F1"1/4 MM 700	10		28,07
		AS 112.800	M1"1/4 x F1"1/4 MM 800	5		30,32
		AS 112.900	M1"1/4 x F1"1/4 MM 900	5		32,23
		AS 112.1000	M1"1/4 x F1"1/4 MM 1000	5		34,24



Art. 112





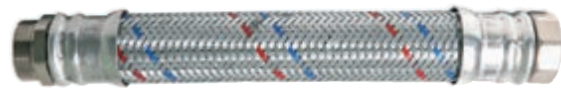





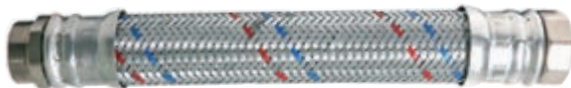

Tubo Flessibile	Treccia INOX	CODICE PRODOTTO	DESCRIZIONE	UDC MINIMA	UNITÀ DI VENDITA	PREZZI EUR <i>escl. IVA</i>
<b>M 1"1/2</b>	<b>F 1"1/2</b>	AR 114.300	M1" 1/2 x F1" 1/2 MM 300	10		28,39
		AR 114.350	M1" 1/2 x F1" 1/2 MM 350	10		29,96
		AR 114.400	M1" 1/2 x F1" 1/2 MM 400	10		30,75
		AR 114.450	M1" 1/2 x F1" 1/2 MM 450	10		32,09
		AR 114.500	M1" 1/2 x F1" 1/2 MM 500	10		33,44
		AR 114.600	M1" 1/2 x F1" 1/2 MM 600	10		36,35
		AR 114.700	M1" 1/2 x F1" 1/2 MM 700	5		38,89
		AR 114.800	M1" 1/2 x F1" 1/2 MM 800	5		41,83
		AR 114.900	M1" 1/2 x F1" 1/2 MM 900	5		44,50
		AR 114.1000	M1" 1/2 x F1" 1/2 MM 1000	5		47,20



Art. 114

**M 2"**                      **F 2"**



AE 116.300	M2" x F2" MM 300	10		45,44
AE 116.350	M2" x F2" MM 350	10		46,58
AE 116.400	M2" x F2" MM 400	10		47,90
AE 116.450	M2" x F2" MM 450	10		48,80
AE 116.500	M2" x F2" MM 500	10		50,90
AE 116.600	M2" x F2" MM 600	10		52,80
AE 116.700	M2" x F2" MM 700	5		61,25
AE 116.800	M2" x F2" MM 800	5		62,80
AE 116.900	M2" x F2" MM 900	5		63,90
AE 116.1000	M2" x F2" MM 1000	5		65,80

Art. 116

# FLESSIBILI ANTIVIBRANTI INOX

STAINLESS STEEL ANTI-VIBRATION FLEXIBLES

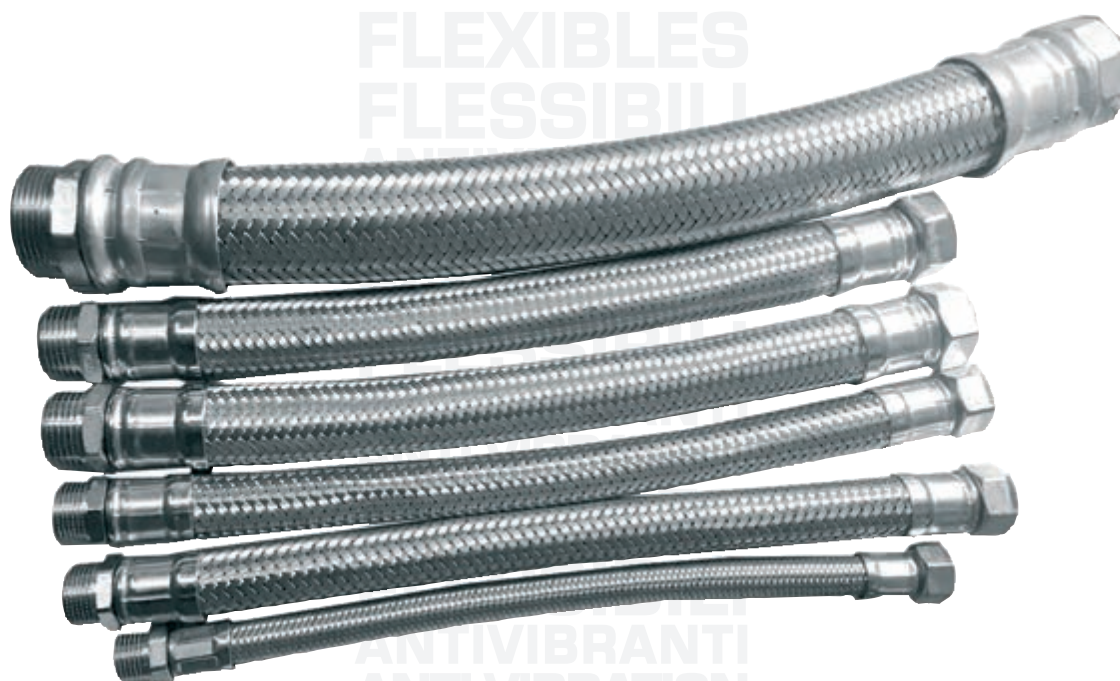

## DATI TECNICI - TECHNICAL DATA:

Flessibili antivibranti made in italy rivestiti con treccia in Acciaio Inox AISI 304 ed interno in tubo in gomma alimentare EPDM utilizzati per il collegamento tra la rete idrica e pompe, caldaie, autoclavi e depuratori, sono disponibili nelle misure da 1/2" fino a 2". Tutti i flessibili sono raccordati con macchine automatiche ed il risultato è l'assoluta precisione di ogni pezzo prodotto per una garanzia di totale qualità.

*Made in Italy anti-vibration flexible hoses, AISI 304 stainless steel braided, with internal in non-toxic EPDM rubber, used for the connection between the water mains and pumps, boilers, autoclaves and water conditioner; available from 1/2" to 2" size. All the hoses are connected with automatic machines and the result is the absolute precision of each produced piece for a total quality guarantee.*



# FLESSIBILI ANTIVIBRANTI INOX



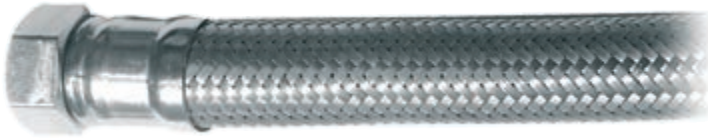

STAINLESS STEEL ANTI-VIBRATION FLEXIBLES



**FLESSIBILE ANTIVIBRANTE**  
**1/2 - 3/4 - 1" - 1"1/4 - 1"1/2 - 2"**  
**TRECCIATO CON FILO DI**  
**ACCIAIO INOX**  
**ATTACCHI DIRITTI**

*FLEXIBLE ANTIVIBRANTE*  
*1/2 - 3/4 - 1" - 1"1/4 - 1"1/2 - 2"*  
*COVERED WITH BRAID OF THREAD*  
*IN STAINLESS STEEL*  
*STRAIGHT CONNECTIONS*

## CARATTERISTICHE - FEATURES:

	PRESSIONE D'ESERCIZIO WORKING PRESSURE 	FLOW RATE AT 3 BAR 	TEMPERATURA D'IMPIEGO WORKING TEMPERATURE 	FORO MINIMO PASSAGGIO D'ACQUA FITTING INNER DIAMETER 	RAGGIO CURVATURA MINIMO MINIMUM BENDING RADIUS 
Tubo Dn13 - 1/2"	15 BAR	65 lit/min	-10°C - +90°C	9,3 mm	45 mm
Tubo Dn19 - 3/4"	15 BAR	120 lit/min	-10°C - +90°C	15 mm	70 mm
Tubo Dn25 - 1"	15 BAR	200 lit/min	-10°C - +90°C	20 mm	100 mm
Tubo Dn32 - 1 1/4"	10 BAR	400 lit/min	-10° C - +90°C	25 mm	190 mm
Tubo Dn40 - 1 1/2"	8 BAR	700 lit/min	-10° C - +90°C	32 mm	210 mm
Tubo Dn50 - 2"	6 BAR	900 lit/min	-10° C - +90°C	41 mm	300 mm

## MATERIALI - MATERIALS

TUBO HOSE		INNER Ø	Ø ESTERNO OUTER Ø	Treccia in Acciaio AISI 304 Tubo interno: gomma EPDM atossico. Braid in Steel AISI 304 Internal pipe: EPDM rubber, atoxic.
			19 mm	
	Tubo Dn19 - 3/4"	19 mm	27 mm	
	Tubo Dn25 - 1"	25 mm	33 mm	
FITTINGS		CW614N CW617N		Ottone CW614N e CW617N giallo o nichelato Brass CW614N and CW617N yellow or nickel plated
BUSSOLE SLEEVES		Alluminio 99,5% Aluminium 99,5%		

Tubo Flessibile	Treccia INOX	CODICE PRODOTTO	DESCRIZIONE	UDC MINIMA	UNITÀ DI VENDITA	PREZZI EUR <i>escl. IVA</i>
<b>M 1/2"</b>	<b>F 1/2"</b>	AA 118.300	M 1/2 x F1/2 MM 300	10		4,85
		AA 118.350	M 1/2 x F1/2 MM 350	10		5,25
		AA 118.400	M 1/2 x F1/2 MM 400	10		5,65
		AA 118.450	M 1/2 x F1/2 MM 450	10		6,10
		AA 118.500	M 1/2 x F1/2 MM 500	10		6,40
		AA 118.600	M 1/2 x F1/2 MM 600	10		6,90
		AA 118.700	M 1/2 x F1/2 MM 700	10		7,50
		AA 118.800	M 1/2 x F1/2 MM 800	10		7,80
		AA 118.900	M 1/2 x F1/2 MM 900	10		9,89
		AA 118.1000	M 1/2 x F1/2 MM 1000	10		10,80













Art. 118

**M 3/4"**
**F 3/4"**

<b>M 3/4"</b>	<b>F 3/4"</b>	AF 120.300	M 3/4 x F3/4 MM 300	10		6,95
		AF 120.350	M 3/4 x F3/4 MM 350	10		7,35
		AF 120.400	M 3/4 x F3/4 MM 400	10		7,75
		AF 120.450	M 3/4 x F3/4 MM 450	10		8,25
		AF 120.500	M 3/4 x F3/4 MM 500	10		8,95
		AF 120.600	M 3/4 x F3/4 MM 600	10		9,95
		AF 120.700	M 3/4 x F3/4 MM 700	10		12,85
		AF 120.800	M 3/4 x F3/4 MM 800	10		13,25
		AF 120.900	M 3/4 x F3/4 MM 900	10		14,75
		AF 120.1000	M 3/4 x F3/4 MM 1000	10		15,15

Art. 120













Tubo Flessibile	Treccia INOX	CODICE PRODOTTO	DESCRIZIONE	UDC MINIMA	UNITÀ DI VENDITA	PREZZI EUR <i>escl. IVA</i>
<b>M 1"</b>	<b>F 1"</b>	AB 122.300	M 1" x F 1" MM 300	10		13,35
		AB 122.350	M 1" x F 1" MM 350	10		13,90
		AB 122.400	M 1" x F 1" MM 400	10		14,65
		AB 122.450	M 1" x F 1" MM 450	10		14,90
		AB 122.500	M 1" x F 1" MM 500	10		15,85
		AB 122.600	M 1" x F 1" MM 600	10		16,55
		AB 122.700	M 1" x F 1" MM 700	5		18,94
		AB 122.800	M 1" x F 1" MM 800	5		19,95
		AB 122.900	M 1" x F 1" MM 900	5		22,80
		AB 122.1000	M 1" x F 1" MM 1000	5		24,15













Art. 122

**M 1" 1/4**
**F 1" 1/4**

Art. 124

AC 124.300	M 1" 1/4 x F 1" 1/4 MM 300	10		28,20
AC 124.350	M 1" 1/4 x F 1" 1/4 MM 350	10		29,16
AC 124.400	M 1" 1/4 x F 1" 1/4 MM 400	10		30,53
AC 124.450	M 1" 1/4 x F 1" 1/4 MM 450	10		31,75
AC 124.500	M 1" 1/4 x F 1" 1/4 MM 500	10		32,86
AC 124.600	M 1" 1/4 x F 1" 1/4 MM 600	10		35,41
AC 124.700	M 1" 1/4 x F 1" 1/4 MM 700	5		37,83
AC 124.800	M 1" 1/4 x F 1" 1/4 MM 800	5		40,22
AC 124.900	M 1" 1/4 x F 1" 1/4 MM 900	5		42,23
AC 124.1000	M 1" 1/4 x F 1" 1/4 MM 1000	5		44,24











Tubo Flessibile		CODICE PRODOTTO	DESCRIZIONE	UDC MINIMA	UNITÀ DI VENDITA	PREZZI EUR <i>escl. IVA</i>
<b>M 1" 1/2</b>	<b>F 1" 1/2</b>	AD 126.300	M 1"1/2 x F1/2 MM 300	10		38,39
		AD 126.350	M 1"1/2 x F1/2 MM 350	10		40,96
		AD 126.400	M 1"1/2 x F1/2 MM 400	10		41,75
		AD 126.450	M 1"1/2 x F1/2 MM 450	10		42,09
		AD 126.500	M 1"1/2 x F1/2 MM 500	10		43,34
		AD 126.600	M 1"1/2 x F1/2 MM 600	10		46,35
		AD 126.700	M 1"1/2 x F1/2 MM 700	5		48,89
		AD 126.800	M 1"1/2 x F1/2 MM 800	5		51,83
		AD 126.900	M 1"1/2 x F1/2 MM 900	5		54,50
		AD 126.1000	M 1"1/2 x F1/2 MM 1000	5		57,20



Art. 126

**M 2"**
**F 2"**

Art. 128

AQ 128.300	M 2" x F 2" MM 300	10		52,44
AQ 128.350	M 2" x F 2" MM 350	10		53,58
AQ 128.400	M 2" x F 2" MM 400	10		55,90
AQ 128.450	M 2" x F 2" MM 450	10		56,80
AQ 128.500	M 2" x F 2" MM 500	10		58,90
AQ 128.600	M 2" x F 2" MM 600	10		60,80
AQ 128.700	M 2" x F 2" MM 700	5		64,25
AQ 128.800	M 2" x F 2" MM 800	5		70,80
AQ 128.900	M 2" x F 2" MM 900	5		75,10
AQ 128.1000	M 2" x F 2" MM 1000	5		80,80

### Dati Tecnici

**Tubo:** acciaio inossidabile AISI 304.

**Raccordo maschio:** acciaio inossidabile AISI 303, filettatura da normativa EN 14800.

**Canotto portagirello:** acciaio inox, sede di tenuta come da normativa EN 14800.

**Dado:** acciaio inox, filettatura come normativa EN 14800

**Treccia:** acciaio inossidabile AISI 304, Ø filo 0,25 mm, 4 fili per trefolo, totale 96 fili.

**Guaina di protezione:** PVC di colore giallo.

**Guarnizioni:** gomma nitrilica secondo normativa EN 549.

Flessibile in acciaio inox con treccia metallica e rivestimento esterno. Per il collegamento di apparecchi per uso domestico e similari (cucine, ecc.) con portata termica nominale non maggiore di 35 Kw alla rete del gas, questo giunto è costruito secondo la norma europea EN 14800 e coperto dal marchio CE.

La protezione esterna è finalizzata a proteggere il tubo da eventuali aggressioni dell'ambiente circostante.

### Technical data

**Hose:** stainless steel AISI 304

**Male fitting:** stainless steel AISI 303, thread as per EN 14800 standard

**Ferrule:** stainless steel AISI 303, seal in compliance with EN 14800 standard.

**Nut:** stainless steel AISI 303 thread conform to EN 14800 standard.

**Braid:** stainless steel AISI 304, wire Ø 0,25 mm, 4 wires for each group, for a total of 96 wires

**Protective cover:** yellow PVC

**Gasket:** nitrile rubber as per EN 549 standard.

*Stainless steel hose made of a metallic braid and an external coating.*

*The ideal solution for connecting gas household appliances (stoves etc.) with nominal heat input not exceeding 35 kw to gas supply lines.*

*This hose is manufactured in compliance with the European Standard EN 14800 and carries the CE mark.*

*The external plastic coating aims at protecting the hose from potential damage caused by the surrounding environment.*



**F 1/2" GIREVOLE**  
REVOLVING F 1/2"



**F 1/2" GIREVOLE**  
REVOLVING F 1/2"



**F 1/2" GIREVOLE**  
REVOLVING F 1/2"



**M 1/2"**



CODICE PRODOTTO	DESCRIZIONE	UDC MINIMA	UNITÀ DI VENDITA	PREZZI EUR escl. IVA
FLEXGASEU.500	F1/2 x F1/2 mm 500	1		19,80
FLEXGASEU.1250	F1/2 x F1/2 mm 1000	1		23,70
FLEXGASEU.1500	F1/2 x F1/2 mm 1250	1		27,00
FLEXGASEU.2000	F1/2 x F1/2 mm 1500	1		29,30
FLEXGASEU.1000	F1/2 x F1/2 mm 2000	1		31,70

FLEXGASMEU.500	F1/2 x M1/2 mm 500	1		19,80
FLEXGASMEU.1250	F1/2 M1/2 mm 1000	1		23,70
FLEXGASMEU.1500	F1/2 x M1/2 mm 1250	1		27,00
FLEXGASMEU.2000	F1/2 M1/2 mm 1500	1		29,30
FLEXGASMEU.1000	F1/2 x M1/2 mm 2000	1		31,70



**Hydro** è un flessibile in acciaio inox austenitico per collegare gli impianti utilizzatori alle condutture senza alcun vincolo strutturale rigido e con il massimo della sicurezza.

**Hydro** is an austenitic stainless steel hose to connect the enduser's system to the piping with no rigid structural restrictions, and the greatest safety.

**Hydro** può essere inoltre utilizzato per tubazioni ad uso alimentare in quanto tutte le parti a contatto con il liquido sono realizzate in acciaio inox austenitico.

**Hydro** can also be installed for food use piping because all the components in contact with the liquid are austenitic stainless steel made.

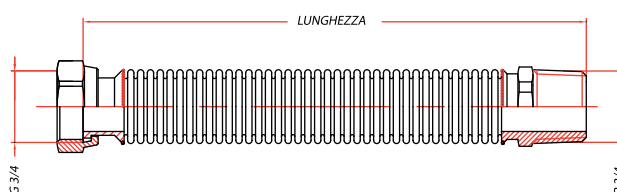

CODICE PRODOTTO	DESCRIZIONE	UDC MINIMA	UNITÀ DI VENDITA	PREZZI EUR escl. IVA
HGA.220 1/2	F1/2 x F1/2 mm 130/220	1		11,85
HGA.420 1/2	F1/2 x F1/2 mm 220/420	1		14,10
HGA.470 1/2	F1/2 x F1/2 mm 470/630	1		16,15
HGA.220 3/4	F3/4 x F3/4 mm 130/220	1		16,85
HGA.420 3/4	F3/4 x F3/4 mm 220/420	1		19,50
HGA.470 3/4	F3/4 x F3/4 mm 470/630	1		23,65
HGA.220 1"	F1" x F1" mm 130/220	1		24,85
HGA.420 1"	F1" x F1" mm 220/420	1		16,10
HGA.470 1"	F1" x F1" mm 470/630	1		31,15
HYD.220 1/2	F1/2 x F1/2 mm 130/220	1		9,40
HYD.420 1/2	F1/2 x F1/2 mm 220/420	1		9,88
HYD.470 1/2	F1/2 x F1/2 mm 470/630	1		12,15
HYD.220 3/4	F3/4 x F3/4 mm 130/220	1		13,85
HYD.420 3/4	F3/4 x F3/4 mm 220/420	1		15,50
HYD.470 3/4	F3/4 x F3/4 mm 470/630	1		17,65
HYD.220 1"	F1" x F1" mm 130/220	1		19,85
HYD.420 1"	F1" x F1" mm 220/420	1		22,10
HYD.470 1"	F1" x F1" mm 470/630	1		24,75





## KIT CALDAIA 130/200 MM

			COMPOSIZIONE			
COD. KIT CALDAIA	TIPO CONFEZ.	PREZZO LISTINO		NR. PEZZI	MISURA MINIMA E MASSIMA	FILETTATURA M - F
Art. 1322	SCATOLA	€ 39,00	FLEX ACQUA	2	130/200 mm	1/2" x 1/2"
			FLEX ACQUA	2	130/200 mm	3/4" x 3/4"
			FLEX GAS	1	130/200 mm	3/4" x 3/4"

			COMPOSIZIONE			
COD. KIT CALDAIA	TIPO CONFEZ.	PREZZO LISTINO		NR. PEZZI	MISURA MINIMA E MASSIMA	FILETTATURA M - F
Art. 1324	BUSTA	€ 36,50	FLEX ACQUA	2	130/200 mm	1/2" x 1/2"
			FLEX ACQUA	2	130/200 mm	3/4" x 3/4"
			FLEX GAS	1	130/200 mm	3/4" x 3/4"

			COMPOSIZIONE			
COD. KIT CALDAIA	TIPO CONFEZ.	PREZZO LISTINO		NR. PEZZI	MISURA MINIMA E MASSIMA	FILETTATURA M - F
Art. 1323	SCATOLA	€ 37,00	FLEX ACQUA	2	130/200 mm	1/2" x 1/2"
			FLEX ACQUA	2	130/200 mm	3/4" x 3/4"
			FLEX GAS	1	130/200 mm	1/2" x 1/2"

			COMPOSIZIONE			
COD. KIT CALDAIA	TIPO CONFEZ.	PREZZO LISTINO		NR. PEZZI	MISURA MINIMA E MASSIMA	FILETTATURA M - F
Art. 1325	BUSTA	€ 35,50	FLEX ACQUA	2	130/200 mm	1/2" x 1/2"
			FLEX ACQUA	2	130/200 mm	3/4" x 3/4"
			FLEX GAS	1	130/200 mm	1/2" x 1/2"

## KIT CALDAIA 220/420 MM

			COMPOSIZIONE			
COD. KIT CALDAIA	TIPO CONFEZ.	PREZZO LISTINO		NR. PEZZI	MISURA MINIMA E MASSIMA	FILETTATURA M - F
Art. 1326	SCATOLA	€ 45,00	FLEX ACQUA	2	220/420 mm	1/2" x 1/2"
			FLEX ACQUA	2	220/420 mm	3/4" x 3/4"
			FLEX GAS	1	220/420 mm	3/4" x 3/4"

			COMPOSIZIONE			
COD. KIT CALDAIA	TIPO CONFEZ.	PREZZO LISTINO		NR. PEZZI	MISURA MINIMA E MASSIMA	FILETTATURA M - F
Art. 1328	BUSTA	€ 43,00	FLEX ACQUA	2	220/420 mm	1/2" x 1/2"
			FLEX ACQUA	2	220/420 mm	3/4" x 3/4"
			FLEX GAS	1	220/420 mm	3/4" x 3/4"

			COMPOSIZIONE			
COD. KIT CALDAIA	TIPO CONFEZ.	PREZZO LISTINO		NR. PEZZI	MISURA MINIMA E MASSIMA	FILETTATURA M - F
Art. 1327	SCATOLA	€ 43,00	FLEX ACQUA	2	220/420 mm	1/2" x 1/2"
			FLEX ACQUA	2	220/420 mm	3/4" x 3/4"
			FLEX GAS	1	220/420 mm	1/2" x 1/2"

			COMPOSIZIONE			
COD. KIT CALDAIA	TIPO CONFEZ.	PREZZO LISTINO		NR. PEZZI	MISURA MINIMA E MASSIMA	FILETTATURA M - F
Art. 1329	BUSTA	€ 41,50	FLEX ACQUA	2	220/420 mm	1/2" x 1/2"
			FLEX ACQUA	2	220/420 mm	3/4" x 3/4"
			FLEX GAS	1	220/420 mm	1/2" x 1/2"

### Dati tecnici

Tubi flessibili per GAS uso esterno con chiavetta.  
 Tubo c/treccia acciaio zincato a norma  
 IMQ UNI CIG 7140 (durata 5 anni)  
 Dado filettato passo bombola GPL 20x14 SF-h 16.

### Technical data

*GAS hose with handle for outdoor appliances.  
 Galvanised steel braided hose in compliance with  
 IMQ UNI CIG 7140 (expiration 5 years).  
 Threaded nut 20x14 SF-h 16 for connection on LPG cylinder.*



**F 20X14 SF-H 16 MM**

**F 20X14 SF-H 16 MM CON CHIAVETTA**  
*F 20X14 SF-H 16 MM WITH HANDLE*

CON DADO IN AVP TROP.  
 BRASS NUT



Art. 018



**F 20X14 SF-H 16 MM**







**F 20X14 SF-H 16 MM CON CHIAVETTA**  
*F 20X14 SF-H 16 MM WITH HANDLE*

CON DADO OTTONE  
 BRASS NUT



Art. 009

CODICE PRODOTTO	DESCRIZIONE	UDC MINIMA	UNITÀ DI VENDITA	PREZZI EUR escl. IVA
GASPVC 018.400	F 1/2 x F1/2 mm 400	10		4,80
GASPVC 018.500	F 1/2 x F1/2 mm 500	10		5,30
GASPVC 018.600	F 1/2 x F1/2 mm 600	10		5,70
GASPVC 018.700	F 1/2 x F1/2 mm 700	10		6,40
GASPVC 018.800	F 1/2 x F1/2 mm 800	10		7,10
GASPVC 018.1000	F 1/2 x F1/2 mm 1000	10		7,80

MAN 009.400	F 1/2 x F1/2 mm 400	10		5,80
MAN 009.500	F 1/2 x F1/2 mm 500	10		6,30
MAN 009.600	F 1/2 x F1/2 mm 600	10		6,70
MAN 009.700	F 1/2 x F1/2 mm 700	10		7,40
MAN 009.800	F 1/2 x F1/2 mm 800	10		8,10
MAN 009.1000	F 1/2 x F1/2 mm 1000	10		8,80

Manichetta per centralina con 2 dadi  
 sx H16 in tubo gomma alta pressione  
 20 BAR

*costruione in gomma arancio alta pressione per idrocarburi  
 conformi alla normal / according  
 pressione di esercizio / working pressure  
 pressione di scoppio / explosion pressure*

Flexible hose for place group with 2  
 left nuts H16 in a rubber hose for high  
 pressure 20 BAR

*Hing pressure orange rubber manufacturing for hydrocarbons  
 UNI 7129  
 20 BAR  
 50 BAR*



### F. 20X14 SF - H 16 MM

### F 20X14 SF-H 16 MM CON CHIAVETTA F 20X14 SF-H 16 MM WITH HANDLE

CON DADO IN AVP TROP.  
 BRASS NUT



Art. 388  
 Art. 338





### F. 20X14 SF - H 16 MM

### F 20X14 SF-H 16 MM CON CHIAVETTA F 20X14 SF-H 16 MM WITH HANDLE

CON DADO IN OTTONE  
 BRASS NUT



Art. 188

CODICE PRODOTTO	DESCRIZIONE	UDC MINIMA	UNITÀ DI VENDITA	PREZZI EUR escl. IVA
GASMAN 338.400	F 1/2 x F1/2 mm 400	10		8,90
GASMAN 338.500	F 1/2 x F1/2 mm 500	10		9,90
GASMAN 338.600	F 1/2 x F1/2 mm 600	10		10,70
GASMAN 338.700	F 1/2 x F1/2 mm 700	10		11,40
GASMAN 338.800	F 1/2 x F1/2 mm 800	10		11,90
GASMAN 338.1000	F 1/2 x F1/2 mm 1000	10		12,50

MAN 188.400	F 1/2 x F1/2 mm 400	10		9,50
MAN 188.500	F 1/2 x F1/2 mm 500	10		10,40
MAN 188.600	F 1/2 x F1/2 mm 600	10		11,20
MAN 188.700	F 1/2 x F1/2 mm 700	10		11,90
MAN 188.800	F 1/2 x F1/2 mm 800	10		12,40
MAN 188.1000	F 1/2 x F1/2 mm 1000	10		12,90

HOSES  
FLESSIBILI  
DOCCIA  
SHOWER



HOSES  
FLESSIBILI  
DOCCIA  
SHOWER

## DATI TECNICI - TECHNICAL DATA:

Flessibili per doccia made in italy in svariati modelli e materiali, a soddisfazione di ogni necessità, sia tecnica, che estetica, che economica. Gli articoli in gamma vengono raccordati con doppia ghiera o ghiera e cono, in diverse lunghezze da cm 120 fino a cm 200. Disponibili a richiesta i fuori misura.



### Dati tecnici

Flessibile doccia argento metalizzato.

### Technical data

Silver shower hose



CODICE PRODOTTO	DESCRIZIONE	UDC MINIMA	€	€
MM666.1000	F1/2 x F1/2 mm 1000	1	7,50	10,00
MM666.1250	F1/2 x F1/2 mm 1250	1	8,00	10,50
MM666.1500	F1/2 x F1/2 mm 1500	1	8,50	11,50
MM666.1750	F1/2 x F1/2 mm 1750	1	9,00	12,00
MM666.2000	F1/2 x F1/2 mm 2000	1	9,50	12,50

F 1/2"

F 1/2" CONICA  
CONICAL F 1/2"



Art. 666

F 1/2" CONICA  
CONICAL F 1/2"

F 1/2" CONICA  
GIREVOLE  
CONICAL REVOLVING F 1/2"



Art. 668

MM668.1000	F1/2 x F1/2 mm 1000	1	7,85	10,40
MM668.1250	F1/2 x F1/2 mm 1250	1	8,50	10,90
MM668.1500	F1/2 x F1/2 mm 1500	1	8,95	12,30
MM668.1750	F1/2 x F1/2 mm 1750	1	9,50	12,90
MM668.2000	F1/2 x F1/2 mm 2000	1	11,50	13,00

### Dati tecnici

Flessibile doccia cromo **SPIRO FLEX**  
 Tubo omologato KTW-C

### Technical data

*Spiro flex shower hose*  
*Approvals KTW-C*



		CODICE PRODOTTO	DESCRIZIONE	UDC MINIMA	€	€
F 1/2"	F 1/2" CONICA CONICAL F 1/2"	AR2029.1000	F 1/2 x F 1/2 mm 1000	1	5,50	8,00
		AR2029.1250	F 1/2 x F 1/2 mm 1250	1	6,00	9,50
		AR2029.1500	F 1/2 x F 1/2 mm 1500	1	7,00	10,50
		AR2029.1750	F 1/2 x F 1/2 mm 1750	1	7,50	11,00
		AR2029.2000	F 1/2 x F 1/2 mm 2000	1	8,00	11,50



Art. 2029

### Dati tecnici

Flessibile doccia cromo  
**DOCCIALUX**

### Technical data

*Doccialux shower hose*



CODICE PRODOTTO	DESCRIZIONE	UDC MINIMA	€	€
CZ2020.1000	F 1/2 x F 1/2 mm 1000	1	6,50	9,00
CZ2020.1250	F 1/2 x F 1/2 mm 1250	1	7,00	9,50
CZ2020.1500	F 1/2 x F 1/2 mm 1500	1	7,50	10,00
CZ2020.1750	F 1/2 x F 1/2 mm 1750	1	8,00	10,50
CZ2020.2000	F 1/2 x F 1/2 mm 2000	1	8,50	11,00

F 1/2"



Art. 2020

F 1/2" CONICA  
 CONICAL F 1/2"



F 1/2" CONICA  
 CONICAL F 1/2"



Art. 2323

F 1/2" CONICA  
 GIREVOLE  
 CONICAL REVOLVING F 1/2"



CV2323.1000	F1/2 x F1/2 mm 1000	1	7,00	9,50
CV2323.1250	F1/2 x F1/2 mm 1250	1	7,50	10,00
CV2323.1500	F1/2 x F1/2 mm 1500	1	8,00	10,50
CV2323.1750	F1/2 x F1/2 mm 1750	1	9,00	11,00
CV2323.2000	F1/2 x F1/2 mm 2000	1	10,00	11,50



### FLESSIBILI DOCCIA SPRINGFLEX

Flessibile Stretch-flex Ø 17 mm 1/2" x 1/2" FF conico  
 Stretch-flex hose, Ø 17 mm, 1/2" x 1/2" FF conical nuts  
 Brauseschlauch Stretch-flex Ø 17 mm 1/2" x 1/2" F Konus  
 Flexible Stretch-flex Ø 17 mm 1/2" x 1/2" F embouts coniques  
 Flexible Stretch-flex Ø 17 mm 1/2" x 1/2" H racores cónicos  
 Шланг Stretch-flex Ø 17 mm 1/2" x 1/2" FF конусообр

F 1/2"	F 1/2" CONICA GIREVOLE CONICAL REVOLVING F 1/2"	CODICE PRODOTTO	DESCRIZIONE	UDC MINIMA	€ 📦	€ 📦
		SP670.1000	F 1/2 x F 1/2 mm 1000	1	7,30	9,50
		SP670.1250	F 1/2 x F 1/2 mm 1250	1	8,50	10,00
		SP670.1500	F 1/2 x F 1/2 mm 1500	1	8,50	11,50
		SP670.1750	F 1/2 x F 1/2 mm 1750	1	9,30	12,50
		SP670.2000	F 1/2 x F 1/2 mm 2000	1	10,50	13,00

Art. 670

M 15x1 GIREVOLE  
 PER DOCCIA ESTRAIBILE  
 REVOLVING 15x1 M. FOR PULL OUT SHOWER

F 1/2" CONICA  
 GIREVOLE  
 CONICAL REVOLVING F 1/2"



Art. 672

SP672.1000	F1/2 x F1/2 mm 1000	1	8,50	10,50
SP672.1250	F1/2 x F1/2 mm 1250	1	9,00	11,00
SP672.1500	F1/2 x F1/2 mm 1500	1	9,50	13,00
SP672.1750	F1/2 x F1/2 mm 1750	1	10,00	13,00
SP672.2000	F1/2 x F1/2 mm 2000	1	10,50	13,50



# FLESSIBILI DOCCIA ESTRAIBILE

PULL OUT FLEXIBLE HOSES





## DATI TECNICI - TECHNICAL DATA:

I flessibili estraibili made in italy sono trecciati e raccordati per il miglior confort in cucina o nelle altre possibili installazioni. La gamma varia dai trecciati in acciaio inox o in nylon colorato fino agli inox ricoperti in pvc. Tutti i flessibili estraibili sono dotati di maschio girevole e attacco girevole antitorsione, per una maggiore praticità d'uso.

The pull-out Made in Italy hoses are braided and connected for the best comfort in the kitchen or in the other possible installations. The range varies from stainless steel, or colored nylon, braided hoses up to the stainless steel hoses covered in pvc. All the pull-out flexible hoses are equipped with a swivelling male and a swivelling anti-torsion connection, for the most practical use.

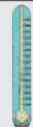
## CARATTERISTICHE - FEATURES:

	PRESSIONE D'ESERCIZIO 	TEMPERATURA D'IMPIEGO WORKING TEMPERATURE 	FORO MINIMO PASSAGGIO D'ACQUA FITTING INNER DIAMETER 	RAGGIO CURVATURA MINIMO MINIMUM BENDING RADIUS 
Tubo Dn8		-10°C - +90°C	6 mm	30 mm

## MATERIALI - MATERIALS

TUBO HOSE		Treccia in NYLON - Tubo interno: gomma EPDM atossico NYLONBraid - Internal pipe: EPDM rubber, atoxic.
		Treccia Inox AISI 304 - Tubo interno: gomma EPDM atossico Braid Stainless AISI 304 - Internal pipe: EPDM rubber, atoxic.
		Treccia in Acciaio Inox AISI 304 ricoperto in PVC colorato Tubo interno: gomma EPDM atossico Braid stainless steel AISI 304 coated with colored PVC Internal pipe: EPDM rubber, atoxic.
RACCORDI FITTINGS		Ottone CW614N e CW617N nichelato o cromato Brass CW614N and CW617N nickel plated or chrome plated
SLEEVES		Ø 12 mm Stainless steel AISI 304



# FLESSIBILI DOCCIA ESTRAIBILE

PULL OUT FLEXIBLE HOSES

**F. 3/8"**



**F. 1/2"**



**F. 1/2"**



**F. 1/2"**



**F. 1/2"**



**F. 1/2" conica**  
*Conical F. 1/2"*



**F. 1/2"**



**M. 15x1**







CODICE PRODOTTO	DESCRIZIONE	UDC MINIMA	UNITÀ DI VENDITA	€
NYLON M.1000	F3/8 x F1/2 mm 1000	1		5,50
NYLON M.1500	F3/8 x F1/2 mm 1500	1		6,50
NYLON M.2000	F3/8 x F1/2 mm 2000	1		7,50

NYLON R.1000	F1/2 x F1/2 mm 1000	1		5,60
NYLON R.1500	F1/2 x F1/2 mm 1500	1		6,70
NYLON R.2000	F1/2 x F1/2 mm 2000	1		7,80





NYLONCON.1000	F1/2 x F1/2 mm 1000	1		6,50
NYLONCON.1500	F1/2 x F1/2 mm 1500	1		7,50
NYLONCON.2000	F1/2 x F1/2 mm 2000	1		8,50

NYLONMAS.1000	F1/2 x M15 mm 1000	1		7,50
NYLONMAS.1500	F1/2 x M15 mm 1500	1		8,50
NYLONMAS.2000	F1/2 x M15 mm 2000	1		9,50

		CODICE PRODOTTO	DESCRIZIONE	UDC MINIMA	UNITÀ DI VENDITA	PREZZI EUR escl. IVA
<b>M10</b> <b>F1/2</b> <b>FLESSIBILE DOCCETTA ESTRAIBILE PER LAVELLO CUCINA TRECCIA INOX</b> <i>FLEXIBLE EXTRACTABLE HAND SHOWER FOR KITCHEN SINK STAINLESS STEEL</i>		MCF 820.1000	M10 x FC1/2 - 1000 MM	1		6,60
		MCF 820.1200	M10 x FC1/2 - 1200 MM	1		6,90
		MCF 820.1500	M10 x FC1/2 - 1500 MM	1		7,20
		MCF 820.2000	M10 x FC1/2 - 2000 MM	1		8,50



Art.820

		CODICE PRODOTTO	DESCRIZIONE	UDC MINIMA	UNITÀ DI VENDITA	PREZZI EUR escl. IVA
<b>M3/8</b> <b>F1/2</b> <b>FLESSIBILE DOCCETTA ESTRAIBILE PER LAVELLO CUCINA TRECCIA INOX</b> <i>FLEXIBLE EXTRACTABLE HAND SHOWER FOR KITCHEN SINK STAINLESS STEEL</i>		CFM 760.1000	M3/8 x FC1/2 - 1000 MM	1		6,80
		CFM 760.1200	M3/8 x FC1/2 - 1200 MM	1		7,10
		CFM 760.1500	M3/8 x FC1/2 - 1500 MM	1		7,30
		CFM 760.2000	M3/8 x FC1/2 - 2000 MM	1		8,80



Art. 760

**F 3/4" CON CURVA RACCORDI IN ABS**

CODICE PRODOTTO	DESCRIZIONE	UDC MINIMA	UNITÀ DI VENDITA	€
TGV.1500	F3/4xFC 3/4 mm 1500	1		2,56
TGV.2000	F3/4xFC 3/4 mm 2000	1		3,16
TGV.2500	F3/4xFC 3/4 mm 2500	1		3,66
TGV.3000	F3/4xFC 3/4 mm 3000	1		4,16

**F 3/4" RACCORDI IN ABS SENZA CURVA**

F 3/4"

F 3/4"



PVC.1500	F3/4xFC 3/4 mm 1500	1		2,46
PVC.2000	F3/4xFC 3/4 mm 2000	1		2,96
PVC.2500	F3/4xFC 3/4 mm 2500	1		3,46
PVC.3000	F3/4xFC 3/4 mm 3000	1		3,96

**F 3/4" RACCORDI IN OTTONE SENZA CURVA TRECCIA INOX**

F 3/4"

F 3/4"



INO.1500	F3/4xFC 3/4 mm 1500	1		6,00
INO.2000	F3/4xFC 3/4 mm 2000	1		7,10
INO.2500	F3/4xFC 3/4 mm 2500	1		8,60
INO.3000	F3/4xFC 3/4 mm 3000	1		10,50

F 3/4"

F 3/4"



INX.1500	F3/4xFC 3/4 mm 1500	1		6,90
INX.2000	F3/4xFC 3/4 mm 2000	1		7,80
INX.2500	F3/4xFC 3/4 mm 2500	1		9,50
INX.3000	F3/4xFC 3/4 mm 3000	1		11,50

**F 3/4" RACCORDI IN OTTONE SENZA CURVA**

F 3/4"





F 3/4"



NIO.1500	F3/4xFC 3/4 mm 1500	1		4,56
NIO.2000	F3/4xFC 3/4 mm 2000	1		5,70
NIO.2500	F3/4xFC 3/4 mm 2500	1		6,90
NIO.3000	F3/4xFC 3/4 mm 3000	1		7,90

# TUBO CARICO LAVATRICE

WASHING MACHINE HOSES

Tubo CARICO LAVATRICE	Treccia NYLON	CODICE PRODOTTO	DESCRIZIONE	UDC MINIMA	UNITÀ DI VENDITA	PREZZI EUR escl. IVA
<b>F3/4</b>	<b>F3/4</b>	SDC 1112.1000	F3/4 x F3/4 - 1000 MM	1		4,30
		SDC 1112.1500	F3/4 x F3/4 - 1500 MM	1		6,29
		SDC 1112.2000	F3/4 x F3/4 - 2000 MM	1		6,45
		SDC 1112.2500	F3/4 x F3/4 - 2500 MM	1		7,50
		SDC 1112.3000	F3/4 x F3/4 - 3000 MM	1		9,10



Art.1112





<b>F3/4 CON CURVA ELBOW F 1/2"</b>	<b>F3/4</b>	CODICE PRODOTTO	DESCRIZIONE	UDC MINIMA	UNITÀ DI VENDITA	PREZZI EUR escl. IVA
<b>F3/4 CON CURVA ELBOW F 1/2"</b>	<b>F3/4</b>	SMR 7481.1000	FC3/4 x F3/4 - 1000 MM	1		4,60
		SMR 7481.1500	FC3/4 x F3/4 - 1500 MM	1		5,68
		SMR 7481.2000	FC3/4 x F3/4 - 2000 MM	1		6,75
		SMR 7481.2500	FC3/4 x F3/4 - 2500 MM	1		7,91
		SMR 7481.3000	FC3/4 x F3/4 - 3000 MM	1		9,20



Art. 7481

# TUBO SCARICOLAVATRICE

WASHING MACHINE HOSES

111.1000	CM 100	1		1,65
111.1500	CM 150	1		1,95
111.2000	CM 200	1		2,45
111.3000	CM 300	1		3,10



Art. 111

## RUBINETTO ARRESTO A SFERA COMPLETO

Rubinetto arresto a sfera completo	CODICE PRODOTTO	DESCRIZIONE	UDC MINIMA	UNITÀ DI VENDITA	PREZZI EUR escl. IVA
	991	CROMATO 1/2 x 10	1		6,90



Art. 991

## RUBINETTO ARRESTO A SFERA

Rubinetto arresto a sfera	CODICE PRODOTTO	DESCRIZIONE	UDC MINIMA	UNITÀ DI VENDITA	PREZZI EUR escl. IVA
	992	CROMATO 1/2 x 1/2	1		5,40



Art.992

## RUBINETTO LAVATRICE

Rubinetto arresto a sfera	CODICE PRODOTTO	DESCRIZIONE	UDC MINIMA	UNITÀ DI VENDITA	PREZZI EUR escl. IVA
	993	CROMATO 1/2 x 3/4	1		6,10



Art.993



## BORCHIA ALTA PER CANOTTO

### Borchia alta per canotto

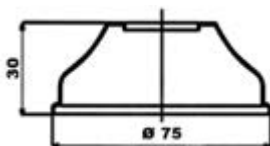

Art. 994



CODICE PRODOTTO	DESCRIZIONE	UDC MINIMA	UNITÀ DI VENDITA	PREZZI EUR escl. IVA
994/26	Ø 26 ottone	30		0,98
994/30	Ø 30 ottone	30		0,98
994/32	Ø 32 ottone	30		0,98



## BORCHIA CONICA

### Borchia conica

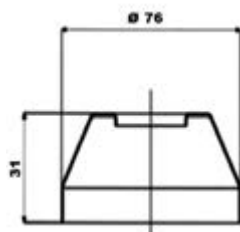

Art. 995



CODICE PRODOTTO	DESCRIZIONE	UDC MINIMA	UNITÀ DI VENDITA	PREZZI EUR escl. IVA
995/26	Ø 26 ottone	30		0,98
995/30	Ø 30 ottone	30		0,98
995/32	Ø 32 ottone	30		0,98

## ROSONE CON FORO ESAGONALE

### Rosone con foro esagonale





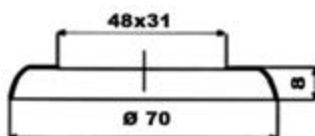







Art. 996













CODICE PRODOTTO	DESCRIZIONE	UDC MINIMA	UNITÀ DI VENDITA	PREZZI EUR escl. IVA
996	Ø 1/2 ottone	30		0,23

## CANOTTO LISCIO

CANOTTO LISCIO		CODICE PRODOTTO	DESCRIZIONE	UDC MINIMA	UNITÀ DI VENDITA	PREZZI EUR escl. IVA
<b>A = Ø 26 - 30 - 32</b> <b>B = MM 200 - 250 - 300</b> 	997.200/26	MM 200 - Ø 26	10		2,35	
	997.200/30	MM 200 - Ø 30	10		2,60	
	997.200/32	MM 200 - Ø 32	10		2,75	
	997.250/26	MM 250 - Ø 26	10		2,75	
	997.250/30	MM 250 - Ø 30	10		2,92	
	997.250/32	MM 250 - Ø 32	10		3,20	
	997.300/26	MM 300 - Ø 26	10		3,25	
	997.300/30	MM 300 - Ø 30	10		3,55	
	997.300/32	MM 300 - Ø 32	10		3,65	

Art. 997

## CANOTTO CON ORLO

CANOTTO CON ORLO		CODICE PRODOTTO	DESCRIZIONE	UDC MINIMA	UNITÀ DI VENDITA	PREZZI EUR escl. IVA
<b>A = Ø 26 - 30 - 32</b> <b>B = MM 200 - 250 - 300</b> 	998.200/26	MM 200 - Ø 26	10		2,45	
	998.200/30	MM 200 - Ø 30	10		2,65	
	998.200/32	MM 200 - Ø 32	10		2,75	
	998.250/26	MM 250 - Ø 26	10		2,85	
	998.250/30	MM 250 - Ø 30	10		3,10	
	998.250/32	MM 250 - Ø 32	10		3,25	
	998.300/26	MM 300 - Ø 26	10		3,35	
	998.300/30	MM 300 - Ø 30	10		3,45	
	998.300/32	MM 300 - Ø 32	10		3,60	

Art. 998





## CANOTTO IN OTTONE RIGATO

CANOTTO RIGATO	CODICE PRODOTTO	DESCRIZIONE	UDC MINIMA	UNITÀ DI VENDITA	PREZZI EUR escl. IVA
<b>A = Ø 26 - 30 - 32</b> <b>B = MM 250 - 300</b>	999.250/26	MM 250 - Ø 26	10		4,25
	999.250/30	MM 250 - Ø 30	10		4,55
	999.250/32	MM 250 - Ø 32	10		4,65
	999.300/26	MM 300 - Ø 26	10		5,65
	999.300/30	MM 300 - Ø 30	10		4,85
	999.300/32	MM 300 - Ø 32	10		5,45



Art. 999

## TUBO "S" ECCENTRICO





TUBO "S" ECCENTRICO	CODICE PRODOTTO	DESCRIZIONE	UDC MINIMA	UNITÀ DI VENDITA	PREZZI EUR escl. IVA
<b>A = Ø 26 - 30 - 32</b> <b>B = MM 300</b>	990.300/26	MM 300 - Ø 26	10		6,80
	990.300/30	MM 300 - Ø 30	10		7,10
	990.300/32	MM 300 - Ø 32	10		7,35



Art. 990

## ATTACCHINO CON CARTELLA DA 1/2







CODICE PRODOTTO	DESCRIZIONE	UDC MINIMA	UNITÀ DI VENDITA	PREZZI EUR escl. IVA
770.300	MM 300	10		3,55
770.350	MM 350	10		3,85
770.400	MM 400	10		4,05
770.500	MM 500	10		4,65
770.1000	MM 1000	10		8,10

Art. 770

## ATTACCHINO CON CARTELLA DA 3/8







CODICE PRODOTTO	DESCRIZIONE	UDC MINIMA	UNITÀ DI VENDITA	PREZZI EUR escl. IVA
771.300	MM 300	10		3,55
771.350	MM 350	10		3,85
771.400	MM 400	10		4,05
771.500	MM 500	10		4,65
771.1000	MM 1000	10		8,10

Art. 771

## ATTACCHINO CON CARTELLA C/NIPPLES COMPLETO PER MONOFORO DA 1/2 O 3/8



CODICE PRODOTTO	DESCRIZIONE	UDC MINIMA	UNITÀ DI VENDITA	PREZZI EUR escl. IVA
772.300	MM 300	10		6,10
772.350	MM 350	10		6,40
772.400	MM 400	10		6,95
772.500	MM 500	10		7,45
772.1000	MM 1000	10		9,30

Art. 772

## ISTRUZIONI MONTAGGIO INSTRUCTIONS

IL MANCATO RISPETTO DELLE ISTRUZIONI ESCLUDE IL PRODUTTORE DA OGNI RESPONSABILITÀ.

Il rispetto di tali indicazioni garantisce le caratteristiche dichiarate dei prodotti e ne assicura la completa affidabilità.

Produttori e distributori sono tenuti alla conoscenza di queste istruzioni ed alla divulgazione agli utenti finali.

Non collegare la messa a terra dell'impianto elettrico al flessibile o ad altra condotta idraulica.

Chiudere l'impianto idraulico in caso di prolungata assenza.

Sostituire il flessibile in caso di piccole perdite e comunque entro i termini di garanzia.

THE MANUFACTURER'S LIABILITY IS EXCLUDED IN CASE OF DISRESPECT OF THESE INSTRUCTIONS.

Please refer to the following instructions for correct use, installation and perfect reliability of flexible hoses. Manufacturers and distributors are required to inform end users accordingly.

Do not connect the electric grounding to the flexible hoses not to any other water piping.

Turn off the plumbing in case of long assemblance. Replace the hoses in case of leakage and anyway, always before the guarantee expiration.

RAGGIO MINIMO DI CURVATURA = RM  
MINIMUM BEND RADIUS = RM

DN6	RM= 25 mm
DN8	RM= 30 mm
DN10	RM= 35 mm
DN13	RM= 45 mm

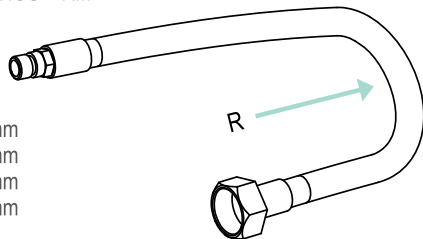

LASCIARE UN TRATTO RETTILINEO PRIMA DELLA CURVATURA A= 2 VOLTE IL DIAMETRO ESTERNO DEL FLESSIBILE.  
A STRAIGHT PART OF 2 TIMES THE EXTERNAL DIAMETER MUST BE BEFORE THE HOSE BENDING A=2 TIMES DIAMETER.

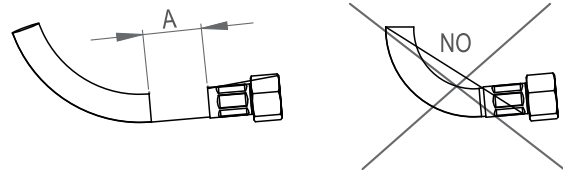

NON FORZARE L'INSERIMENTO DEL RUBINETTO NEGLI ATTACCHI A MURO, LA PARTE FILETTATA POTREBBE CRICCARSÌ DURANTE L'INSTALLAZIONE E CAUSARE PERDITE SUCCESSIVE.

DON'T FORCE THE FAUCET THREAD IN THE WALL CONNECTORS, THE THREAD COULD CRACK DURING INSTALLATION AND THEN IT CAN CAUSE LEAKS.

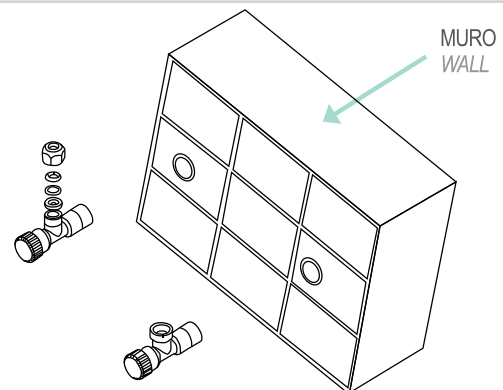

IL CONTATTO PROLUNGATO CON SOSTANZE, ANCHE LEGGERMENTE AGGRESSIVE, POTREBBE CAUSARE IL DANNEGGIAMENTO DEL RIVESTIMENTO A TRECCIA ED IL CONSEGUENTE SCOPPIO DEL FLESSIBILE.

*PROLONGED CONTACT WITH ANY SUBSTANCES, EVEN SCARCELY AGGRESSIVE, COULD CAUSE EXTERNAL BRAID DAMAGE AND THE FLEXIBLE BURST.*

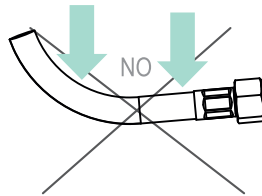

NON INSERIRE I FLESSIBILI NEL MURO.  
*DON'T SET THE FLEXIBLE IN THE WALL*

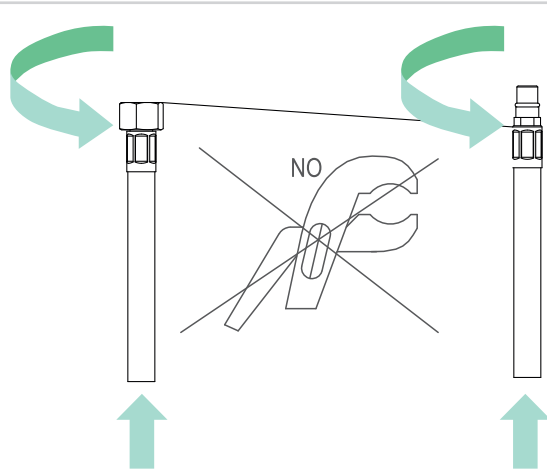
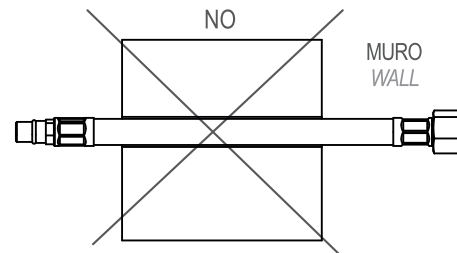

AVVITARE IL DADO A MANO E STRINGERE CON CHIAVE IDONEA 1/4 DI GIRO.  
SCREW THE NUT BY HAND THAN USE AN APPROPRIATE WRENCH FOR 1/4 TURN.

AVVITARE A MANO I RACCORDI CON OR COPPIA MAX 3 Nm.  
SCREW BY HAND THE CONNECTION MAXIMUM TORQUE 3 Nm.

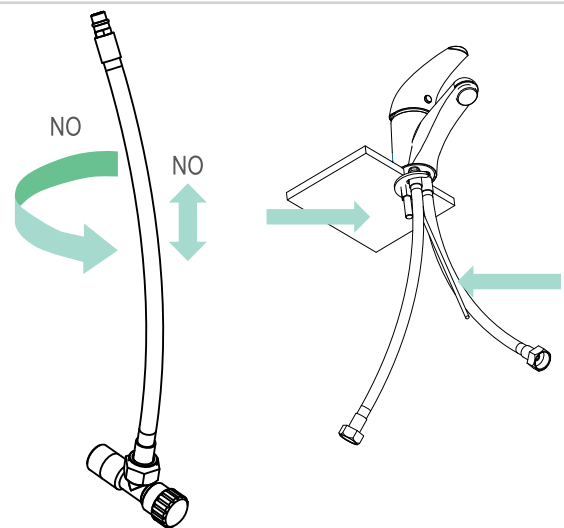

LASCIARE UN TRATTO RETTILINEO PRIMA DELLA CURVATURA  $A=2$  VOLTE IL DIAMETRO ESTERNO DEL FLESSIBILE.  
*A STRAIGHT PART OF 2 TIMES THE EXTERNAL DIAMETER MUST BE BEFORE THE HOSE BENDING  $A=2$  TIMES DIAMETER.*

PRIMA DELL'INSTALLAZIONE VERIFICARE LA PRESENZA E L'INTEGRITA' DELLE GRAFFATURE ALLE 2 ESTREMITA' DEL FLESSIBILE.  
*CHECK THE CRIMPINGS ON THE 2 FLEXIBLE ENDS BEFORE INSTALLATION.*

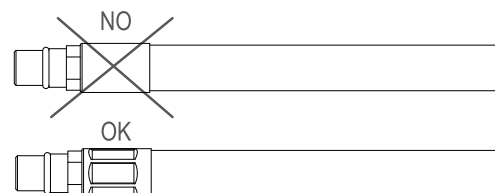

## Responsabilità del produttore / *Manufacturer's liability*

CDflex assicura garanzia di responsabilità ai sensi della norma europea nr. 85/374/CEE del 24-05-88 e D.P.R. 224 riguardanti la responsabilità del produttore. Per tale motivo, i prodotti CDflex sono contrassegnati dal marchio di fabbrica e dall'anno di produzione per facilitarne l'identificazione. L'indennizzo per eventuali danni, nei soli casi riconducibili alla responsabilità del produttore, consisterà nella sostituzione gratuita del pezzo difettoso e nel risarcimento del solo utente finale, purché il danno venga debitamente comprovato mediante perizia. In ogni caso, restano escluse da qualsiasi risarcimento le spese sostenute, direttamente o indirettamente, da terzi come rivenditori e installatori, per trasporti, viaggi, sopralluoghi, smontaggi, rimontaggi, resi di materiale ecc.

### **ESCLUSIONE RESPONSABILITA'**

La responsabilità del produttore è esclusa nei seguenti casi:

- a) I prodotti non sono contrassegnati dal marchio né da un altro segno identificativo, esclusi accordi speciali riportati nella conferma d'ordine.
- b) In caso di installazione e uso scorretto del flessibile. E' essenziale che gli installatori seguano le istruzioni con la massima attenzione, poiché la minima inavvertenza potrebbe causare, in breve tempo, scarsa tenuta o danneggiamento del flessibile.
- c) I tubi non sono ispezionabili.
- d) Se i danni sono dovuti a ossidazione, corrosione, erosione elettrostatica e tensocorrosione. Tali fenomeni possono infatti intaccare i componenti del flessibile in acciaio zincato, ottone o acciaio inossidabile AISI 304 ed essere innescati dall'ambiente circostante, da eventuali dispersioni di corrente e detersivi. Persino l'acqua potabile può risultare chimicamente aggressiva e provocare danni da corrosione.

*CDflex is liable for its production in compliance with EU regulation nr. 85/374/CEE dated 24-05-88 and D.P.R. 224 concerning the manufacturer's liability.*

*Therefore, CDflex products bear a trademark and the manufacturing year for an easier identification.*

*Indemnity for damage, only if due to manufacturer's liability, shall consist in free replacement of the defected article and compensation to the sole end user for damage duly confirmed through appraisal. In any case, no indemnity is due in case of expenses, either directly or indirectly, covered by a third party like retailers or plumbers, for transportation, travel, inspections, disassembly, assembly, returned goods etc.*

### **LIMITATION OF LIABILITY**

*The manufacturer's liability is excluded in the following cases:*

- a) *the products do not bear either the trademark or any other identification mark excluding special arrangements mentioned in the order confirmation.*
- b) *In case of wrong installation and use. Installers must read the instructions very carefully since the slightest carelessness could cause inadequate wet seal or hose damage in short time.*
- c) *If hoses are not available for inspection.*
- d) *Moreover, any damage due to oxidation, corrosion, electrostatic erosion and stress corrosion will not be refunded. As a matter of fact, hose components made of galvanized steel, brass or AISI 304 stainless steel could undergo the above mentioned processes which are likely to be favoured by the surrounding environment, power dispersion and detergents. Even drinking water, can turn out to be chemically aggressive and cause corrosion.*

## Condizioni generali di vendita / *General sale conditions*

Le seguenti condizioni generali di vendita si intendono valide per tutti i contratti stipulati con CDFLEX e accettate dai clienti al momento dell'ordine. Gli ordini vengono evasi salvo disponibilità e le relative consegne possono essere effettuate anche parzialmente. Le vendite sono sempre considerate franco fabbrica se non diversamente specificato. I termini di consegna non sono vincolanti bensì soggetti alle esigenze di produzione. Eventuali ritardi non daranno diritto al cliente di cancellare l'ordine o pretendere risarcimenti di alcuna natura. I prezzi possono essere soggetti a variazioni. Inoltre, sono ritenuti vincolanti unicamente i prezzi espressi nella conferma d'ordine. L'IVA potrà essere addebitata nella misura prevista dalle normative vigenti. Eventuali reclami, per qualunque motivo, dovranno pervenire tassativamente entro e non oltre otto giorni dal ricevimento della merce, pena l'accettazione del reclamo stesso. In caso di pezzi mancanti, sarà necessario specificare il numero di colli ricevuti ed il codice del tagliando di controllo inserito in ogni collo. Il materiale difettoso verrà sostituito alle seguenti condizioni:

1. Se concordato precedentemente per iscritto;
2. In caso di materiale di recente produzione;
3. In caso di difetti di fabbricazione;
4. Se l'acquisto non è stato perfezionato da più di novanta giorni;
5. Ammesso che il materiale venga spedito in porto franco con regolare bolla di reso contenente i dati della bolla di consegna e della fattura d'acquisto.

I danni causati da installazione impropria e da uso scorretto del prodotto non sono coperti da alcuna garanzia. Il pagamento deve essere effettuato entro i termini riportati nella conferma d'ordine e in fattura. In caso di ritardato pagamento, verranno addebitati gli interessi di mora. Inoltre, il mancato pagamento di fatture alla scadenza comporterà la sospensione degli ordini in corso. Illustrazioni e caratteristiche tecniche possono essere modificate in qualsiasi momento senza preavviso. CDFLEX si riserva il diritto di apportare tutte le modifiche che ritenga necessarie per migliorare il funzionamento dei propri prodotti. In caso di controversia, il foro competente è unicamente quello di VIBO VALENTIA.

ai sensi degli articoli 28-29 c. p. c.

Vendita convenuta con patto di riservato dominio ai sensi dell'art. 1523 e seguenti C.C..

I beni rimangono di proprietà del fornitore fino al pagamento integrale del prezzo pattuito.

**Figure e misure sono indicative, pertanto non vincolanti.**

*The following sale conditions are to be considered as valid for all contracts drawn up with CDFLEX and tacitly accepted by customers when placing orders. Since complete fulfillment of an order is subject to availability, also partial deliveries must be accepted. Sales are always effected ex-works if not differently specified. Delivery terms are not binding but submitted to the demands of production. The purchaser is neither entitled to cancel the order nor to claim damage because of late deliveries. Prices can be subject to modification. Moreover, only prices appearing in the order confirmation are to be considered as binding. VAT will be levied in the extent provided by law in force only. Any claim, for whatever reason, must be filed within and not later than 8 days from receipt of the goods, otherwise they will not be accepted. In case of incorrect supplied quantities, the number of received packages and the code of the coupon distributed in each package will have to be specified. Defected articles will be replaced on the following conditions:*

1. *If previously agreed in written terms;*
2. *In case of recent production;*
3. *In case of manufacturing defects;*
4. *If the purchase dates back to no more than ninety days before;*
5. *The material to be replaced is returned on the purchaser's expenses together with a return note complete with delivery bill and invoice data.*

*CDFLEX is neither liable for inappropriate installation nor for wrong use of the supplied goods. Payment must be settled within the terms established in the order confirmation and invoice. In case of delayed payment, the purchaser will be debited interest on arrears. Moreover, CDFLEX has the right to suspend deliveries of insolvent customers. Illustrations and drawings can be modified without notice. CDFLEX reserves the right to modify its products to improve performance. VIBO VALENTIA*

*court only will be competent in case of dispute in accordance with articles 28-29 of civil law.*

*Sale agreed under retention of title according to art. 1523 and subs. of the Civil Code.*

*The goods shall remain the supplier's property until full payment of the negotiated price.*

***Pictures and sizes are merely indicative therefore not binding.***

**IMPORTANTE**

Compilare il presente modulo in ogni sua parte anticipando a mezzo fax 0963 351534, oppure a mezzo mail: info@cdflex.it.

Diversamente ci riserviamo la facoltà di respingere il reso

**Dati Cliente**

Regione sociale: .....

Referente Sig.: .....

	Pezzi da rendere	Codice articolo	Data di acquisto	Numero fattura acquisto	Descrizione difetto
1					
2					
3					
4					
5					
6					
7					
8					
9					
10					
11					
12					
13					
14					
15					
16					
17					
18					
19					
20					

Numero colli .....

Peso totale spedizione .....

**Condizioni di resa**

La merce resa dovrà essere resa alla Cdflex in porto franco ed idoneamente imballata.

La sostituzione dei prodotti difettosi avverrà solo dopo la verifica effettuata dal nostro personale preposto al controllo qualità.

Accertato il difetto di fabbricazione, l'ufficio commerciale predisporrà per la sostituzione della merce.

Cdflex SRLS Zona Ind.le Via I° Maggio - 89831 Soriano Calabro (VV)

Tel. +39 0963 352039 - Fax +39 0963 351534

www.cdflex.it - info@cdflex.it







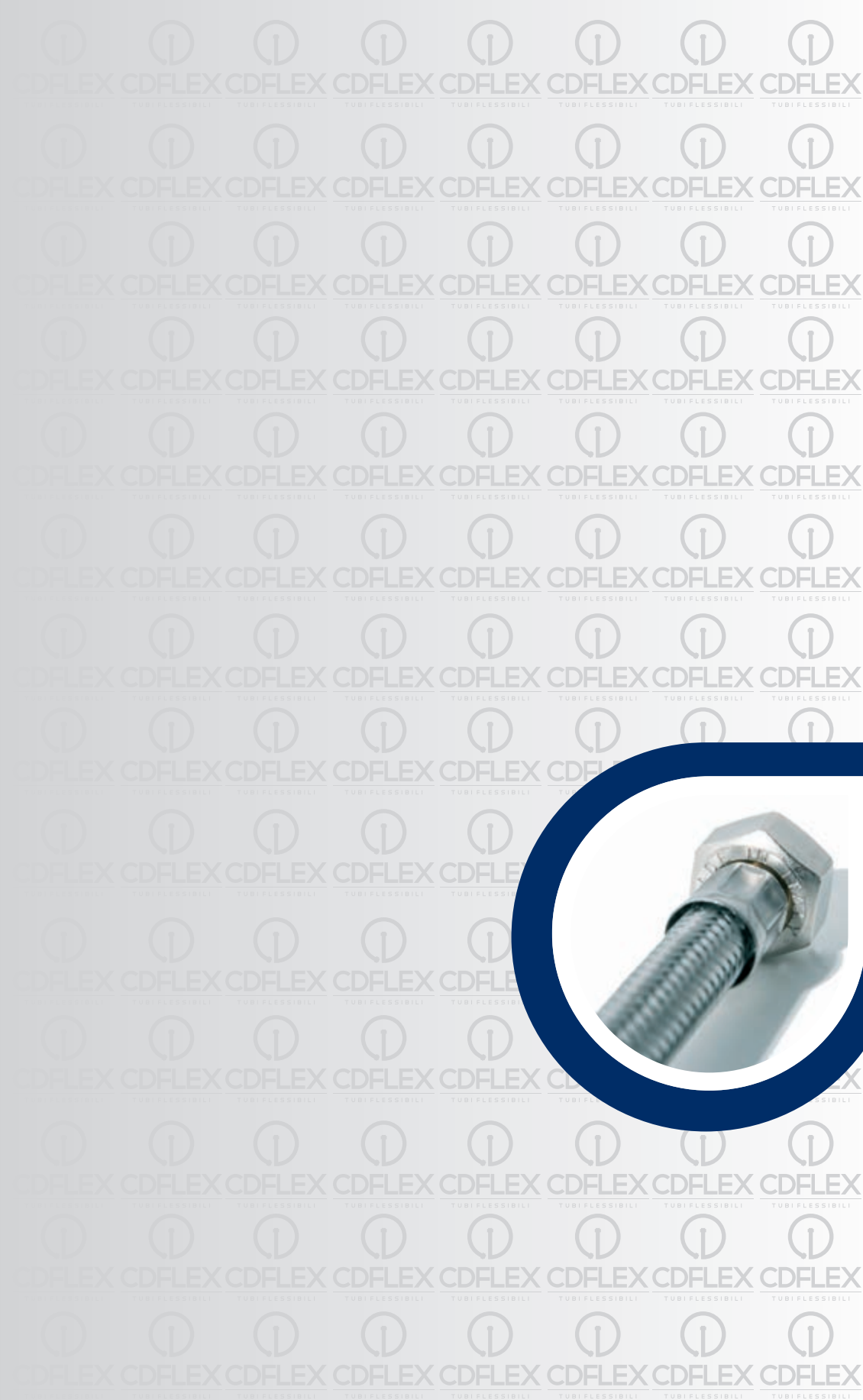

**CDFLEX**



Via I° Maggio, Zona Industriale  
89831 Soriano Calabro (VV)



**Tel.** +39 0963 352039  
**Fax:** +39 0963 351534



**email:** [info@cdflex.it](mailto:info@cdflex.it)  
[www.cdflex.it](http://www.cdflex.it)