

# FLESSIBILI DN 10

**FLESSIBILI PER RUBINETTERIA E SANITARI**  
 FLEXIBLES FOR FAUCES AND SANITARIES









DISPONIBILE SU RICHIESTA CON TRECCIA TRICOLORE

## DATI TECNICI - TECHNICAL DATA:

Tubo flessibile trecciato made in Italy in acciaio Inox AISI 304 con interno in gomma alimentare EPDM utilizzato prevalentemente per il collegamento tra la rete idrica e i rubinetti singoli, gli scaldabagni, le pareti doccia attrezzate e le vasche idromassaggio oltre che ai rubinetti posti sulle cucine industriali. Tutti i flessibili sono raccordati con macchine automatiche ed il risultato è l'assoluta precisione di ogni pezzo prodotto per una garanzia di totale qualità.

*Made in Italy braided hose in AISI 304 stainless steel with internal in non-toxic EPDM rubber, mainly used for the connection between the water mains and the single faucet, the boilers, the equipped shower sets and the hydromassage tubs, besides the taps are placed on industrial kitchens. All the hoses are produced with automatic machines and the result is the absolute precision of each produced piece for a total quality guarantee.*











## CARATTERISTICHE - FEATURES:

TEMPERATURA INSTALLAZIONE INSTALLATION TEMPERATURE 	PRESSIONE D'ESERCIZIO WORKING PRESSURE 	PORTATA A 3 BAR FLOW RATE AT 3 BAR 	TEMPERATURA D'IMPIEGO WORKING TEMPERATURE 	FORO MINIMO PASSAGGIO D'ACQUA FITTING INNER DIAMETER 	RAGGIO CURVATURA MINIMO MINIMUM BENDING RADIUS 
da -5°C a +90°C	10 BAR	42 lit/min	-5°C - +90°C	7 mm	35 mm

## MATERIALI - MATERIALS











TUBO HOSE 	Ø INTERNO INNER Ø 10 mm OUTER Ø 14 mm	Treccia 7-8 fili Ø 0,22mm in acciaio Inox AISI 304 Tubo interno: gomma EPDM atossico. 7-8 wires braid Ø 0,22mm in stainless steel Inox AISI 304 Internal pipe: EPDM rubber, atoxic.
RACCORDI FITTINGS 	CW614N CW617N	Ottone CW614N e CW617N nichelato Brass CW614N and CW617N nickel plated
BUSSOLE SLEEVES 	Ø 16 mm	Acciaio Inox AISI 304 Stainless Steel AISI 304



Tubo Flessibile	Treccia INOX	CODICE PRODOTTO	DESCRIZIONE	UDC MINIMA	UNITÀ DI VENDITA	PREZZI EUR <i>escl. IVA</i>
<b>F 1/2"</b>	<b>F 1/2"</b>	FN 005.150	F1/2x F1/2 MM 150	50		1,97
		FN 005.200	F1/2x F1/2 MM 200	50		2,09
		FN 005.250	F1/2x F1/2 MM 250	50		2,22
		FN 005.300	F1/2x F1/2 MM 300	50		2,35
		FN 005.350	F1/2x F1/2 MM 350	50		2,50
		FN 005.400	F1/2x F1/2 MM 400	50		2,65
		FN 005.450	F1/2x F1/2 MM 450	50		2,78
		FN 005.500	F1/2x F1/2 MM 500	50		2,97
		FN 005.600	F1/2x F1/2 MM 600	10		3,17
		FN 005.800	F1/2x F1/2 MM 800	10		3,77
		FN 005.1000	F1/2x F1/2 MM 1000	10		4,12













Art. 005

<b>M 3/8"</b>	<b>F 3/8"</b>	MF 007.150	M3/8 x F3/8 MM 150	50		2,00
		MF 007.200	M3/8 x F3/8 MM 200	50		2,12
		MF 007.250	M3/8 x F3/8. MM 250	50		2,24
		MF 007.300	M3/8 x F3/8 MM 300	50		2,37
		MF 007.350	M3/8 x F3/8 MM 350	50		2,52
		MF 007.400	M3/8 x F3/8 MM 400	50		2,67
		MF 007.450	M3/8 x F3/8 MM 450	50		2,80
		MF 007.500	M3/8 x F3/8 MM 500	50		2,99
		MF 007.600	M3/8 x F3/8 MM 600	10		3,19
		MF 007.800	M3/8 x F3/8 MM 800	10		3,79
		MF 007.1000	M3/8 x F3/8 MM 1000	10		4,14













Art. 007

Tubo Flessibile	Treccia INOX	CODICE PRODOTTO	DESCRIZIONE	UDC MINIMA	UNITÀ DI VENDITA	PREZZI EUR <i>escl. IVA</i>
<b>F 3/8"</b>	<b>F 3/8"</b>	FF 001.150	F3/8x F3/8 MM 150	50		1,93
		FF 001.200	F3/8x F3/8 MM 200	50		2,05
		FF 001.250	F3/8x F3/8 MM 250	50		2,18
		FF 001.300	F3/8x F3/8 MM 300	50		2,31
		FF 001.350	F3/8x F3/8 MM 350	50		2,43
		FF 001.400	F3/8x F3/8 MM 400	50		2,58
		FF 001.450	F3/8x F3/8 MM 450	50		2,71
		FF 001.500	F3/8x F3/8 MM 500	50		2,90
		FF 001.600	F3/8x F3/8 MM 600	10		3,10
		FF 001.800	F3/8x F3/8 MM 800	10		3,70
		FF 001.1000	F3/8x F3/8 MM 1000	10		4,05













Art. 001

<b>F 3/8"</b>	<b>F 1/2"</b>	FR 003.150	F3/8 x F1/2 MM 150	50		1,95
		FR 003.200	F3/8 x F1/2 MM 200	50		2,073
		FR 003.250	F3/8 x F1/2 MM 250	50		2,20
		FR 003.300	F3/8 x F1/2 MM 300	50		2,33
		FR 003.350	F3/8 x F1/2 MM 350	50		2,48
		FR 003.400	F3/8 x F1/2 MM 400	50		2,63
		FR 003.450	F3/8 x F1/2 MM 450	50		2,76
		FR 003.500	F3/8 x F1/2 MM 500	50		2,95
		FR 003.600	F3/8 x F1/2 MM 600	10		3,15
		FR 003.800	F3/8 x F1/2 MM 800	10		3,75
		FR 003.1000	F3/8 x F1/2 MM 1000	10		410













Art. 003

Tubo Flessibile	Treccia INOX	CODICE PRODOTTO	DESCRIZIONE	UDC MINIMA	UNITÀ DI VENDITA	PREZZI EUR escl. IVA
<b>M 3/8"</b>	<b>F 1/2"</b>	MT 301 .150	M3/8 x F1/2 MM 150	50		1,99
		MT 301 .200	M3/8 x F1/2 MM 200	50		2,09
		MT 301 .250	M3/8 x F1/2 MM 250	50		2,24
		MT 301 .300	M3/8 x F1/2 MM 300	50		2,36
		MT 301 .350	M3/8 x F1/2 MM 350	50		2,48
		MT 301 .400	M3/8 x F1/2 MM 400	50		2,60
		MT 301 .450	M3/8 x F1/2 MM 450	50		2,72
		MT 301 .500	M3/8 x F1/2 MM 500	50		2,96
		MT 301 .600	M3/8 x F1/2 MM 600	10		3,24
		MT 301 .800	M3/8 x F1/2 MM 800	10		3,76
		MT 301 .1000	M3/8 x F1/2 MM 1000	10		4,00













Art. 301

<b>M 1/2"</b>	<b>F 3/8"</b>	MZ 321.150	M 1/2 x F3/8 MM 150	50		2,02
		MZ 321.200	M 1/2 x F3/8 MM 200	50		2,11
		MZ 321.250	M 1/2 x F3/8. MM 250	50		2,26
		MZ 321.300	M 1/2 x F3/8 MM 300	50		2,38
		MZ 321.350	M 1/2 x F3/8 MM 350	50		2,50
		MZ 321.400	M 1/2 x F3/8 MM 400	50		2,62
		MZ 321.450	M 1/2 x F3/8 MM 450	50		2,74
		MZ 321.500	M 1/2 x F3/8 MM 500	50		2,98
		MZ 321.600	M 1/2 x F3/8 MM 600	10		3,27
		MZ 321.800	M 1/2 x F3/8 MM 800	10		3,79
		MZ 321.1000	M 1/2 x F3/8 MM 1000	10		4,05















Art. 321

Tubo Flessibile	Treccia INOX	CODICE PRODOTTO	DESCRIZIONE	UDC MINIMA	UNITÀ DI VENDITA	PREZZI EUR <i>escl. IVA</i>
<b>M 1/2"</b>	<b>F 1/2"</b>	ME 311.150	M1/2 x F1/2 MM 150	50		2,04
		ME 311.200	M1/2 x F1/2 MM 200	50		2,13
		ME 311.250	M1/2 x F1/2 MM 250	50		2,28
		ME 311.300	M1/2 x F1/2 MM 300	50		2,40
		ME 311.350	M1/2 x F1/2 MM 350	50		2,52
		ME 311.400	M1/2 x F1/2 MM 400	50		2,64
		ME 311.450	M1/2 x F1/2 MM 450	50		2,76
		ME 311.500	M1/2 x F1/2 MM 500	50		3,00
		ME 311.600	M1/2 x F1/2 MM 600	10		3,29
		ME 311.800	M1/2 x F1/2 MM 800	10		3,83
		ME 311.1000	M1/2 x F1/2 MM 1000	10		4,07



Art. 311

M 3/8"	F 1/2" CON GUARNIZIONE INSERITA INSERTED GASKET					
		CA 421.150	M3/8 x F1/2 MM 150	50		2,19
		CA 421.200	M3/8 x F1/2 MM 200	50		2,26
		CA 421.250	M3/8 x F1/2. MM 250	50		2,34
		CA 421.300	M3/8 x F1/2 MM 300	50		2,44
		CA 421.350	M3/8 x F1/2 MM 350	50		2,55
		CA 421.400	M3/8 x F1/2 MM 400	50		2,65
		CA 421.450	M3/8 x F1/2 MM 450	50		2,85
		CA 421.500	M3/8 x F1/2 MM 500	50		3,05
		CA 421.600	M3/8 x F1/2 MM 600	10		3,25
		CA 421.800	M3/8 x F1/2 MM 800	10		3,30
		CA 421.1000	M3/8 x F1/2 MM 1000	10		3,45

Art. 421

Tubo Flessibile	Treccia INOX	CODICE PRODOTTO	DESCRIZIONE	UDC MINIMA	UNITÀ DI VENDITA	PREZZI EUR <i>escl. IVA</i>
<b>M 1/2"</b>	<b>F 3/8"</b> CON GUARNIZIONE INSERITA <i>INSERTED GASKET</i>	CB 422.150	M1/2 x F3/8 MM 150	50		2,23
		CB 422.200	M1/2 x F3/8 MM 200	50		2,31
		CB 422.250	M1/2 x F3/8 MM 250	50		2,39
		CB 422.300	M1/2 x F3/8 MM 300	50		2,50
		CB 422.350	M1/2 x F3/8 MM 350	50		2,60
		CB 422.400	M1/2 x F3/8 MM 400	50		2,71
		CB 422.450	M1/2 x F3/8 MM 450	50		2,90
		CB 422.500	M1/2 x F3/8 MM 500	50		3,10
		CB 422.600	M1/2 x F3/8 MM 600	10		3,30
		CB 422.800	M1/2 x F3/8 MM 800	10		3,40
		CB 422.1000	M1/2 x F3/8 MM 1000	10		3,60

Art. 422





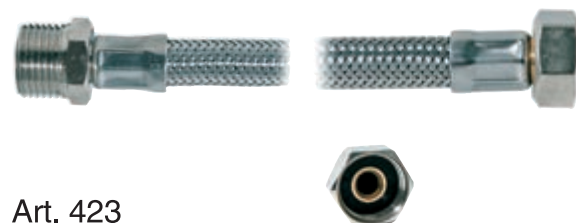





**M 1/2"**

**F 1/2"**  
CON GUARNIZIONE  
INSERITA  
*INSERTED GASKET*



Art. 423

CC 423.150	M1/2 x F1/2 MM 150	50		2,28
CC 423.200	M1/2 x F1/2 MM 200	50		2,33
CC 423.250	M1/2 x F1/2. MM 250	50		2,44
CC 423.300	M1/2 x F1/2 MM 300	50		2,54
CC 423.350	M1/2 x F1/2 MM 350	50		2,65
CC 423.400	M1/2 x F1/2 MM 400	50		2,75
CC 423.450	M1/2 x F1/2 MM 450	50		2,95
CC 423.500	M1/2 x F1/2 MM 500	50		3,15
CC 423.600	M1/2 x F1/2 MM 600	10		3,35
CC 423.800	M1/2 x F1/2 MM 800	10		3,55
CC 423.1000	M1/2 x F1/2 MM 1000	10		3,77

Tubo Flessibile	Treccia INOX	CODICE PRODOTTO	DESCRIZIONE	UDC MINIMA	UNITÀ DI VENDITA	PREZZI EUR <i>escl. IVA</i>
<b>MP 3/8"</b> <b>MASCHIO PROLUNGATO</b> <i>EXTENDED M 3/8"</i>	<b>F 3/8"</b>	MP 201.150	MP 3/8 x F3/8 MM 150	50		2,43
		MP 201.200	MP 3/8 x F3/8 MM 200	50		2,54
		MP 201.250	MP 3/8 x F3/8 MM 250	50		2,67
		MP 201.300	MP 3/8 x F3/8 MM 300	50		2,79
		MP 201.350	MP 3/8 x F3/8 MM 350	50		2,94
		MP 201.400	MP 3/8x F3/8 MM 400	50		3,05
		MP 201.450	MP 3/8 x F3/8 MM 450	50		3,19
		MP 201.500	MP 3/8 x F3/8 MM 500	50		3,39
		MP 201.600	MP 3/8 x F3/8 MM 600	10		3,69
		MP 201.800	MP 3/8 x F3/8 MM 800	10		4,19
		MP 201.1000	MP 3/8 x F3/8 MM 1000	10		4,49



Art. 201











**MP 3/8"**  
**MASCHIO PROLUNGATO**  
*EXTENDED M 3/8"*

**F 1/2"**

MP 202.150	MP 3/8x F1/2 MM 150	50		2,45
MP 202.200	MP 3/8x F1/2 MM 200	50		2,56
MP 202.250	MP 3/8 x F1/2. MM 250	50		2,69
MP 202.300	MP 3/8x F1/2 MM 300	50		2,81
MP 202.350	MP 3/8 x F1/2 MM 350	50		2,96
MP 202.400	MP 3/8 x F1/2 MM 400	50		3,07
MP 202.450	MP 3/8 x F1/2 MM 450	50		3,21
MP 202.500	MP 3/8 x F1/2 MM 500	50		3,41
MP 202.600	MP 3/8 x F1/2 MM 600	10		3,71
MP 202.800	MP 3/8 x F1/2 MM 800	10		4,21
MP 202.1000	MP 3/8x F1/2 MM 1000	10		4,51



Art. 202

Tubo Flessibile	Treccia INOX	CODICE PRODOTTO	DESCRIZIONE	UDC MINIMA	UNITÀ DI VENDITA	PREZZI EUR escl. IVA
<b>M 1/2"</b> <b>MASCHIO PROLUNGATO</b> <i>EXTENDED M 1/2"</i>	<b>F 3/8"</b>	MX 204.150	MP 1/2 x F3/8 MM 150	50		2,69
		MX 204.200	MP 1/2x F3/8 MM 200	50		2,82
		MX 204.250	MP 1/2 x F3/8 MM 250	50		2,94
		MX 204.300	MP 1/2x F3/8 MM 300	50		3,07
		MX 204.350	MP 1/2 x F3/8 MM 350	50		3,20
		MX 204.400	MP1/2x F3/8 MM 400	50		3,34
		MX 204.450	MP 1/2x F3/8 MM 450	50		3,47
		MX 204.500	MP 1/2 x F3/8 MM 500	50		3,68
		MX 204.600	MP 1/2x F3/8 MM 600	10		3,93
		MX 204.800	MP 1/2 x F3/8 MM 800	10		4,35
		MX 204.1000	MP 1/2x F3/8 MM 1000	10		4,73











Art. 204

<b>MP 1/2"</b> <b>MASCHIO PROLUNGATO</b> <i>EXTENDED M 1/2"</i>	<b>F 1/2"</b>	MJ 220.150	MP 1/2x F1/2 MM 150	50		2,73
		MJ 220.200	MP 1/2x F1/2 MM 200	50		2,86
		MJ 220.250	MP 1/2 x F1/2 MM 250	50		2,98
		MJ 220.300	MP 1/2x F1/2 MM 300	50		3,11
		MJ 220.350	MP 1/2 x F1/2 MM 350	50		3,23
		MJ 220.400	MP 1/2 x F1/2 MM 400	50		3,38
		MJ 220.450	MP 1/2 x F1/2 MM 450	50		3,51
		MJ 220.500	MP 1/2 x F1/2 MM 500	50		3,71
		MJ 220.600	MP 1/2 x F1/2 MM 600	10		3,95
		MJ 220.800	MP 1/2 x F1/2 MM 800	10		4,39
		MJ 220.1000	MP 1/2x F1/2 MM 1000	10		4,76



Art. 220



Tubo Flessibile	Treccia INOX	CODICE PRODOTTO	DESCRIZIONE	UDC MINIMA	UNITÀ DI VENDITA	PREZZI EUR <i>escl. IVA</i>
<b>MP 3/8"</b> <b>MASCHIO PROLUNGATO</b> <i>EXTENDED M 3/8"</i>	<b>F 3/8"</b> <b>CON GUARNIZIONE</b> <b>INSERITA</b> <i>INSERTED GASKET</i>	CD 424.150	MP 3/8 x F3/8 MM 150	50		2,45
		CD 424.200	MP 3/8 x F3/8 MM 200	50		2,50
		CD 424.250	MP 3/8 x F3/8 MM 250	50		2,55
		CD 424.300	MP 3/8 x F3/8 MM 300	50		2,65
		CD 424.350	MP 3/8 x F3/8 MM 350	50		2,70
		CD 424.400	MP 3/8 x F3/8 MM 400	50		2,75
		CD 424.450	MP 3/8 x F3/8 MM 450	50		2,80
		CD 424.500	MP 3/8 x F3/8 MM 500	50		3,00
		CD 424.600	MP 3/8 x F3/8 MM 600	10		3,20
		CD 424.800	MP 3/8 x F3/8 MM 800	10		3,60
		CD 424.1000	MP 3/8 x F3/8 MM 1000	10		3,80



Art. 424



**MP 1/2"**  
**MASCHIO PROLUNGATO**  
*EXTENDED M 1/2"*











**F 1/2"**  
**CON GUARNIZIONE**  
**INSERITA**  
*INSERTED GASKET*



Art. 425



CE 425.150	MP 1/2x F1/2 MM 150	50		2,50
CE 425.200	MP 1/2x F1/2 MM 200	50		2,55
CE 425.250	MP 1/2 x F1/2Z MM 250	50		2,60
CE 425.300	MP 1/2x F1/2 MM 300	50		2,70
CE 425.350	MP 1/2 x F1/2 MM 350	50		2,75
CE 425.400	MP 1/2 x F1/2 MM 400	50		2,85
CE 425.450	MP 1/2 x F1/2 MM 450	50		2,90
CE 425.500	MP 1/2 x F1/2 MM 500	50		3,05
CE 425.600	MP 1/2 x F1/2 MM 600	10		3,25
CE 425.800	MP 1/2 x F1/2 MM 800	10		3,65
CE 425.1000	MP 1/2x F1/2 MM 1000	10		3,95

Tubo Flessibile	Treccia INOX	CODICE PRODOTTO	DESCRIZIONE	UDC MINIMA	UNITÀ DI VENDITA	PREZZI EUR escl. IVA
<b>MP 3/8"</b> <b>MASCHIO PROLUNGATO</b> <b>CON ANELLO PTFE</b> <i>EXTENDED WITH RING M 3/8"</i>	<b>F 3/8"</b>	MU 388.150	MP 3/8 x F3/8 MM 150	50		2,65
		MU 388.200	MP 3/8 x F3/8 MM 200	50		2,73
		MU 388.250	MP 3/8 x F3/8 MM 250	50		2,80
		MU 388.300	MP 3/8 x F3/8 MM 300	50		2,87
		MU 388.350	MP 3/8 x F3/8 MM 350	50		2,94
		MU 388.400	MP 3/8 x F3/8 MM 400	50		3,03
		MU 388.450	MP 3/8 x F3/8 MM 450	50		3,09
		MU 388.500	MP 3/8 x F3/8 MM 500	50		3,22
		MU 388.600	MP 3/8 x F3/8 MM 600	10		3,40
		MU 388.800	MP 3/8 x F3/8 MM 800	10		3,90
		MU 388.1000	MP 3/8 x F3/8 MM 1000	10		4,30



Art. 388











**MP 1/2"**  
**MASCHIO PROLUNGATO**  
**CON ANELLO PTFE**  
*EXTENDED WITH RING M 1/2"*

**F 1/2"**



MH 389.150	MP 1/2x F1/2 MM 150	50		2,75
MH 389.200	MP 1/2x F1/2 MM 200	50		2,83
MH 389.250	MP 1/2 x F1/2 MM 250	50		2,90
MH 389.300	MP 1/2x F1/2 MM 300	50		2,97
MH 389.350	MP 1/2 x F1/2 MM 350	50		3,04
MH 389.400	MP 1/2 x F1/2 MM 400	50		3,13
MH 389.450	MP 1/2 x F1/2 MM 450	50		3,32
MH 389.500	MP 1/2 x F1/2 MM 500	50		3,50
MH 389.600	MP 1/2 x F1/2 MM 600	10		3,70
MH 389.800	MP 1/2 x F1/2 MM 800	10		4,00
MH 389.1000	MP 1/2x F1/2 MM 1000	10		4,40

Art. 389

Tubo Flessibile	Treccia INOX	CODICE PRODOTTO	DESCRIZIONE	UDC MINIMA	UNITÀ DI VENDITA	PREZZI EUR <i>escl. IVA</i>
<b>MP 1/2"</b> <b>MASCHIO PROLUNGATO            CON ANELLO PTFE</b> <i>EXTENDED WITH RING M 1/2"</i>	<b>F 3/8"</b>	MY 340.150	MP 1/2 x F3/8 MM 150	50		3,00
		MY 340.200	MP 1/2 x F3/8 MM 200	50		3,07
		MY 340.250	MP 1/2 x F3/8 MM 250	50		3,14
		MY 340.300	MP 1/2 x F3/8 MM 300	50		3,21
		MY 340.350	MP 1/2 x F3/8 MM 350	50		3,28
		MY 340.400	MP 1/2 x F3/8 MM 400	50		3,36
		MY 340.450	MP 1/2 x F3/8 MM 450	50		3,43
		MY 340.500	MP 1/2 x F3/8 MM 500	50		3,54
		MY 340.600	MP 1/2 x F3/8 MM 600	10		3,69
		MY 340.800	MP 1/2 x F3/8 MM 800	10		4,06
		MY 340.1000	MP 1/2 x F3/8 MM 1000	10		4,50



Art. 340

**MP 1/2"**  
**MASCHIO PROLUNGATO  
 CON ANELLO PTFE**  
*EXTENDED WITH RING M 1/2"*

**F 3/8"**  
**CON GUARNIZIONE  
 INSERITA**  
*INSERTED GASKET*

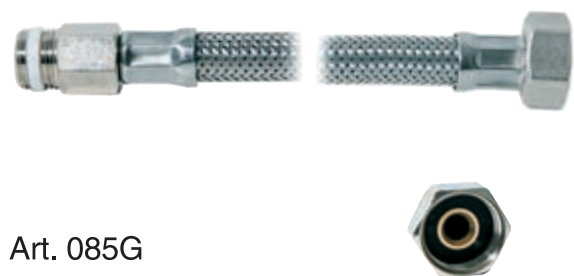







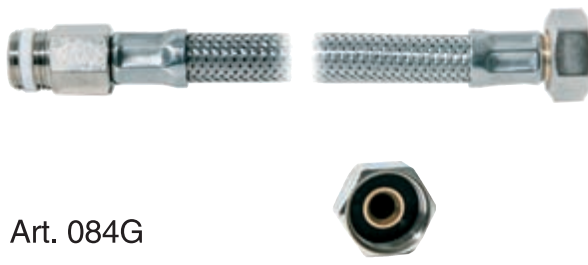



Art. 085G

MG 085.150	MP 1/2 x F3/8 MM 150	50		3,26
MG 085.200	MP 1/2 x F3/8 MM 200	50		3,33
MG 085.250	MP 1/2 x F3/8 MM 250	50		3,38
MG 085.300	MP 1/2 x F3/8 MM 300	50		3,43
MG 085.350	MP 1/2 x F3/8 MM 350	50		3,48
MG 085.400	MP 1/2 x F3/8 MM 400	50		3,64
MG 085.450	MP 1/2 x F3/8 MM 450	50		3,77
MG 085.500	MP 1/2 x F3/8 MM 500	50		3,87
MG 085.600	MP 1/2 x F3/8 MM 600	10		4,07
MG 085.800	MP 1/2 x F3/8 MM 800	10		4,47
MG 085.1000	MP 1/2 x F3/8 MM 1000	10		4,87

Tubo Flessibile	Treccia INOX	CODICE PRODOTTO	DESCRIZIONE	UDC MINIMA	UNITÀ DI VENDITA	PREZZI EUR <i>escl. IVA</i>
<b>MP1/2"</b> <b>MASCHIO PROLUNGATO            CON ANELLO PTFE</b> <i>EXTENDED WITH RING M 1/2"</i>	<b>F 1/2"</b> <b>CON GUARNIZIONE            INSERITA</b> <i>INSERTED GASKET</i>	MP 084.160	MP 1/2 X F1/2 MM 150	50		3,36
		MP 084.200	MP 1/2 X F1/2 MM 200	50		3,41
		MP 084.250	MP 1/2 X F1/2 MM 250	50		3,46
		MP 084.300	MP 1/2 X F1/2 MM 300	50		3,51
		MP 084.350	MP 1/2 X F1/2 MM 350	50		3,67
		MP 084.400	MP 1/2 X F1/2 MM 400	50		3,80
		MP 084.450	MP 1/2 X F1/2 MM 450	50		3,90
		MP 084.500	MP 1/2 X F1/2 MM 500	50		4,10
		MP 084.600	MP 1/2 X F1/2 MM 600	10		4,30
		MP 084.800	MP 1/2 X F1/2 MM 800	10		4,50
		MP 084.1000	MP 1/2 X F1/2 MM 1000	10		4,90











Art. 084G

<b>M 3/8"</b> <b>MASCHIO CORTO            CON ANELLO PTFE</b> <i>SHORT WITH RING M 3/8"</i>	<b>F 3/8"</b>	QW 050.150	M 3/8 x F3/8 MM 150	50		2,85
		QW 050.200	M 3/8 x F3/8 MM 200	50		2,92
		QW 050.250	M 3/8 x F3/8 MM 250	50		2,99
		QW 050.300	M 3/8 x F3/8 MM 300	50		3,06
		QW 050.350	M 3/8 x F3/8 MM 350	50		3,12
		QW 050.400	M 3/8 x F3/8 MM 400	50		3,21
		QW 050.450	M 3/8 x F3/8 MM 450	50		3,33
		QW 050.500	M 3/8 x F3/8 MM 500	50		3,47
		QW 050.600	M 3/8 x F3/8 MM 600	10		3,61
		QW 050.800	M 3/8 x F3/8 MM 800	10		3,76
		QW 050.1000	M 3/8 x F3/8 MM 1000	10		3,93



Art. 050

Tubo Flessibile	Treccia INOX	CODICE PRODOTTO	DESCRIZIONE	UDC MINIMA	UNITÀ DI VENDITA	PREZZI EUR <i>escl. IVA</i>
<b>M 1/2"</b> <b>MASCHIO</b> <b>CON ANELLO PTFE</b> <i>WITH RING M 1/2"</i>	<b>F1/2"</b>	OR 058.150	M 1/2 x F 1/2 MM 150	50		2,90
		OR 058.200	M 1/2 x F 1/2 MM 200	50		2,97
		OR 058.250	M 1/2 x F 1/2 MM 250	50		3,04
		OR 058.300	M 1/2 x F 1/2 MM 300	50		3,10
		OR 058.350	M 1/2 x F 1/2 MM 350	50		3,18
		OR 058.400	M 1/2 x F 1/2 MM 400	50		3,26
		OR 058.450	M 1/2 x F 1/2 MM 450	50		3,39
		OR 058.500	M 1/2 x F 1/2 MM 500	50		3,52
		OR 058.600	M 1/2 x F 1/2 MM 600	10		3,66
		OR 058.800	M 1/2 x F 1/2 MM 800	10		3,81
		OR 058.1000	M 1/2 x F 1/2 MM 1000	10		3,98







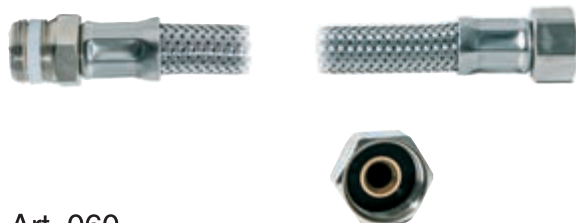





Art. 058

<b>M 1/2"</b> <b>MASCHIO CORTO</b> <b>CON ANELLO PTFE</b> <i>SHORT WITH RING M 3/8"</i>	<b>F 3/8"</b> <b>CON GUARNIZIONE</b> <b>INSERITA</b> <i>INSERTED GASKET</i>	OT 060.150	M 1/2 x F 3/8 MM 150	50		2,98
		OT 060.200	M 1/2 x F 3/8 MM 200	50		3,05
		OT 060.250	M 1/2 x F 3/8 MM 250	50		3,12
		OT 060.300	M 1/2 x F 3/8 MM 300	50		3,17
		OT 060.350	M 1/2 x F 3/8 MM 350	50		3,20
		OT 060.400	M 1/2 x F 3/8 MM 400	50		3,34
		OT 060.450	M 1/2 x F 3/8 MM 450	50		3,45
		OT 060.500	M 1/2 x F 3/8 MM 500	50		3,60
		OT 060.600	M 1/2 x F 3/8 MM 600	10		3,74
		OT 060.800	M 1/2 x F 3/8 MM 800	10		3,89
		OT 060.1000	M 1/2 x F 3/8 MM 1000	10		4,06



Art. 060

Tubo Flessibile	Treccia INOX	CODICE PRODOTTO	DESCRIZIONE	UDC MINIMA	UNITÀ DI VENDITA	PREZZI EUR esc. IVA
<b>M 1/2"</b> <b>MASCHIO CORTO            CON ANELLO PTFE</b> <i>SHORT WITH RING M 1/2"</i>	<b>F 1/2"</b> <b>CON GUARNIZIONE            INSERITA</b> <i>INSERTED GASKET</i>	OV 062.150	M 1/2 x F 1/2 MM 150	50		3,00
		OV 062.200	M 1/2 x F 1/2 MM 200	50		3,07
		OV 062.250	M 1/2 x F 1/2 MM 250	50		3,14
		OV 062.300	M 1/2 x F 1/2 MM 300	50		3,24
		OV 062.350	M 1/2 x F 1/2 MM 350	50		3,38
		OV 062.400	M 1/2 x F 1/2 MM 400	50		3,48
		OV 062.450	M 1/2 x F 1/2 MM 450	50		3,65
		OV 062.500	M 1/2 x F 1/2 MM 500	50		3,89
		OV 062.600	M 1/2 x F 1/2 MM 600	10		3,95
		OV 062.800	M 1/2 x F 1/2 MM 800	10		4,10
		OV 062.1000	M 1/2 x F 1/2 MM 1000	10		4,24

Art. 062





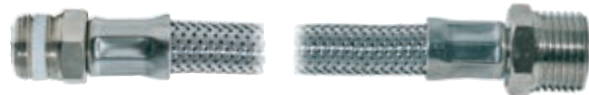





**M 1/2"**  
**MASCHIO CORTO  
 CON ANELLO PTFE**  
*SHORT WITH RING M 1/2"*

**M 1/2"**  
**MASCHIO CORTO**  
*SHORT M 1/2"*



Art. 064

OZ 064.150	M 1/2 x M1/2 MM 150	50		3,09
OZ 064.200	M 1/2 x M1/2 MM 200	50		3,16
OZ 064.250	M 1/2 x M1/2 MM 250	50		3,23
OZ 064.300	M 1/2 x M1/2 MM 300	50		3,31
OZ 064.350	M 1/2 x M1/2 MM 350	50		3,39
OZ 064.400	M 1/2 x M1/2 MM 400	50		3,45
OZ 064.450	M 1/2 x M1/2 MM 450	50		3,53
OZ 064.500	M 1/2 x M1/2 MM 500	50		3,79
OZ 064.600	M 1/2 x M1/2 MM 600	10		3,99
OZ 064.800	M 1/2 x M1/2 MM 800	10		4,16
OZ 064.1000	M 1/2 x M1/2 MM 1000	10		4,60

Tubo Flessibile	Treccia INOX	CODICE PRODOTTO	DESCRIZIONE	UDC MINIMA	UNITÀ DI VENDITA	PREZZI EUR escl. IVA
<b>MP1/2"</b> <b>MASCHIO PROLUNGATO CON ANELLO PTFE</b> <i>EXTENDED WITH RING M 1/2"</i>	<b>MB10</b> <b>MASCHIO BICONE 10 o 12</b> <i>BICONE 10 o 12</i>	MTB 089.150	MP 1/2 x MB10 MM 150	50		3,67
		MTB 089.200	MP 1/2 x MB10 MM 200	50		3,75
		MTB 089.250	MP 1/2 x MB10 MM 250	50		3,83
		MTB 089.300	MP 1/2 x MB10 MM 300	50		3,98
		MTB 089.350	MP 1/2 x MB10 MM 350	50		4,13
		MTB 089.400	MP 1/2 x MB10 MM 400	50		4,26
		MTB 089.450	MP 1/2 x MB10 MM 450	50		4,39
		MTB 089.500	MP 1/2 x MB10 MM 500	50		4,49
		MTB 089.600	MP 1/2 x MB10 MM 600	10		4,78
		MTB 089.800	MP 1/2 x MB10 MM 800	10		5,08
		MTB 089.1000	MP 1/2 x MB10 MM 1000	10		5,49













Art. 089











**MG 1/2"**  
**MASCHIO GIREVOLE**  
*REVOLVING M 1/2"*

**MB10**  
**MASCHIO BICONE 10 o 12**  
*BICONE 10 o 12*













Art. 444

MB 444.150	MG 1/2 x MB10 MM 150	50		3,55
MB 444.200	MG 1/2 x MB10 MM 200	50		3,60
MB 444.250	MG 1/2 x MB10 MM 250	50		3,65
MB 444.300	MG 1/2 x MB10 MM 300	50		3,75
MB 444.350	MG 1/2 x MB10 MM 350	50		3,85
MB 444.400	MG 1/2 x MB10 MM 400	50		3,99
MB 444.450	MG 1/2 x MB10 MM 450	50		4,09
MB 444.500	MG 1/2 x MB10 MM 500	50		4,169
MB 444.600	MG 1/2 x MB10 MM 600	10		4,39
MB 444.800	MG 1/2 x MB10 MM 800	10		4,59
MB 444.1000	MG 1/2 x MB10 MM 1000	10		4,99

Tubo Flessibile	Treccia INOX	CODICE PRODOTTO	DESCRIZIONE	UDC MINIMA	UNITÀ DI VENDITA	PREZZI EUR escl. IVA
<b>MB10</b> <b>MASCHIO BICONE 10 o 12</b> <i>BICONE 10 o 12</i>	<b>F 3/8" o 1/2"</b>	MTX 083.150	MB10 x F3/8 MM 150	50		3,23
		MTX 083.200	MB10 x F3/8 MM 200	50		3,28
		MTX 083.250	MB10 x F3/8 MM 250	50		3,33
		MTX 083.300	MB10 x F3/8 MM 300	50		3,38
		MTX 083.350	MB10 x F3/8 MM 350	50		3,54
		MTX 083.400	MB10 x F3/8 MM 400	50		3,58
		MTX 083.450	MB10 x F3/8 MM 450	50		3,68
		MTX 083.500	MB10 x F3/8 MM 500	50		3,88
		MTX 083.600	MB10 x F3/8 MM 600	10		3,98
		MTX 083.800	MB10 x F3/8 MM 800	10		4,08
		MTX 083.1000	MB10 x F3/8 MM 1000	10		4,38



Art. 083

<b>MB10</b> <b>MASCHIO BICONE 10 o 12</b> <i>BICONE 10 o 12</i>	<b>M 1/2" o 3/8"</b>	MTR 081.150	MB10 x M 1/2 MM 150	50		3,28
		MTR 081.200	MB10 x M 1/2 MM 200	50		3,33
		MTR 081.250	MB10 x M 1/2 MM 250	50		3,38
		MTR 081.300	MB10 x M 1/2 MM 300	50		3,43
		MTR 081.350	MB10 x M 1/2 MM 350	50		3,59
		MTR 081.400	MB10 x M 1/2 MM 400	50		3,63
		MTR 081.450	MB10 x M 1/2 MM 450	50		3,73
		MTR 081.500	MB10 x M 1/2 MM 500	50		3,93
		MTR 081.600	MB10 x M 1/2 MM 600	10		4,05
		MTR 081.800	MB10 x M 1/2 MM 800	10		4,16
		MTR 081.1000	MB10 x M 1/2 MM 1000	10		4,48







Art. 081













Tubo Flessibile	Treccia INOX	CODICE PRODOTTO	DESCRIZIONE	UDC MINIMA	UNITÀ DI VENDITA	PREZZI EUR escl. IVA
<b>M 1/2"</b> <b>MASCHIO GIREVOLE</b> <i>REVOLVING M 1/2"</i> 	<b>F 3/8"</b> <b>CON GUARNIZIONE</b> <b>INSERTITA</b> <i>INSERTED GASKET</i> 	MG 502.150	MG 1/2 x F3/8 MM 150	50		3,20
		MG 502.200	MG 1/2 x F3/8 MM 200	50		3,25
		MG 502.250	MG 1/2x F3/8 MM 250	50		3,35
		MG 502.300	MG 1/2x F3/8 MM 300	50		3,45
		MG 502.350	MG 1/2x F3/8 MM 350	50		3,55
		MG 502.400	MG 1/2x F3/8 MM 400	50		3,70
		MG 502.450	MG 1/2x F3/8 MM 450	50		3,85
		MG 502.500	MG 1/2x F3/8 MM 500	50		4,05
		MG 502.600	MG 1/2x F3/8 MM 600	10		4,25
		MG 502.800	MG 1/2x F3/8 MM 800	10		4,45
		MG 502.1000	MG 1/2x F3/8 MM 1000	10		4,67

Art. 502

<b>M 1/2"</b> <b>MASCHIO GIREVOLE</b> <i>REVOLVING M 1/2"</i> 	<b>F 1/2"</b> <b>CON GUARNIZIONE</b> <b>INSERTITA</b> <i>INSERTED GASKET</i> 	MQ 503.150	MG1/2 x F1/2 MM 150	50		3,25
		MQ 503.200	MG1/2 x F1/2 MM 200	50		3,35
		MQ 503.250	MG1/2 x F1/2 MM 250	50		3,45
		MQ 503.300	MG1/2 x F1/2 MM 300	50		3,55
		MQ 503.350	MG1/2 x F1/2 MM 350	50		3,65
		MQ 503.400	MG1/2 x F1/2 MM 400	50		3,75
		MQ 503.450	MG1/2 x F1/2 MM 450	50		3,85
		MQ 503.500	MG1/2 x F1/2 MM 500	50		3,95
		MQ 503.600	MG1/2 x F1/2 MM 600	10		4,35
		MQ 503.800	MG1/2 x F1/2 MM 800	10		4,55
		MQ 503.1000	MG1/2 x F1/2 MM 1000	10		4,75











Art. 503

Tubo Flessibile	Treccia INOX	CODICE PRODOTTO	DESCRIZIONE	UDC MINIMA	UNITÀ DI VENDITA	PREZZI EUR <i>escl. IVA</i>
<b>M 1/2"</b> <b>MASCHIO PROLUNGATO</b> <b>GIREVOLE</b> <i>EXTENDED REVOLVING M 1/2"</i>	<b>F 3/8"</b> <b>CON GUARNIZIONE</b> <b>INSERITA</b> <i>INSERTED GASKET</i>	MW 501.150	MPG 1/2 x F3/8 MM 150	50		3,40
		MW 501.200	MPG 1/2 x F3/8 MM 200	50		3,50
		MW 501.250	MPG 1/2 x F3/8 MM 250	50		3,60
		MW 501.300	MPG 1/2 x F3/8 MM 300	50		3,70
		MW 501.350	MPG 1/2 x F3/8 MM 350	50		3,80
		MW 501.400	MPG 1/2 x F3/8 MM 400	50		3,90
		MW 501.450	MPG 1/2 x F3/8 MM 450	50		4,00
		MW 501.500	MPG 1/2 x F3/8 MM 500	50		4,24
		MW 501.600	MPG 1/2 x F3/8 MM 600	10		4,44
		MW 501.800	MPG 1/2 x F3/8 MM 800	10		4,66
		MW 501.1000	MPG 1/2 x F3/8 MM 1000	10		5,00

Art. 501

<b>M 1/2"</b> <b>MASCHIO PROLUNGATO</b> <b>GIREVOLE</b> <i>EXTENDED REVOLVING M 1/2"</i>	<b>F.1/2"</b> <b>CON GUARNIZIONE</b> <b>INSERITA</b> <i>INSERTED GASKET</i>	MK 511.150	MPG 1/2x F1/2 MM 150	50		3,5
		MK 511.200	MPG 1/2 x F1/2 MM 200	50		3,55
		MK 511.250	MPG 1/2 x F1/2 MM 250	50		3,75
		MK 511.300	MPG 1/2 x F1/2 MM 300	50		3,85
		MK 511.350	MPG 1/2 x F1/2 MM 350	50		3,95
		MK 511.400	MPG 1/2 x F1/2 MM 400	50		4,05
		MK 511.450	MPG 1/2 x F1/2 MM 450	50		4,25
		MK 511.500	MPG 1/2 x F1/2 MM 500	50		4,45
		MK 511.600	MPG 1/2 x F1/2 MM 600	10		4,60
		MK 511.800	MPG 1/2 x F1/2 MM 800	10		4,75
		MK 511.1000	MPG 1/2 x F1/2 MM 1000	10		5,10

Art. 511

Tubo Flessibile	Treccia INOX	CODICE PRODOTTO	DESCRIZIONE	UDC MINIMA	UNITÀ DI VENDITA	PREZZI EUR <i>escl. IVA</i>
<b>F 3/8"</b> <b>CON DADO H15</b> <b>GUARNIZIONE INSERITA</b> <b>TRECCIA 8 FILI</b> <i>NUT H15 - INSERTED GASKET</i> <i>BRAIDED WIRE</i>	<b>F 3/8"</b> <b>CON DADO H15</b> <b>GUARNIZIONE INSERITA</b> <b>TRECCIA 8 FILI</b> <i>NUT H15 - INSERTED GASKET</i> <i>BRAIDED WIRE</i>	DD 2011.150	F 3/8 x F3/8 MM 150	50		2,85
		DD 2011.200	F 3/8 x F3/8 MM 200	50		2,95
		DD 2011.250	F 3/8x F3/8 MM 250	50		3,05
		DD 2011.300	F 3/8x F3/8 MM 300	50		3,15
		DD 2011.350	F 3/8x F3/8 MM 350	50		3,20
		DD 2011.400	F 3/8x F3/8 MM 400	50		3,25
		DD 2011.450	F 3/8x F3/8 MM 450	50		3,30
		DD 2011.500	F 3/8x F3/8 MM 500	50		3,35
		DD 2011.600	F 3/8x F3/8 MM 600	10		3,55
		DD 2011.800	F 3/8x F3/8 MM 800	10		3,78
		DD 2011.1000	F 3/8x F3/8 MM 1000	10		3,99











Art. 2011

**F1/2"**  
**CON DADO H15**  
**GUARNIZIONE INSERITA**  
**TRECCIA 8 FILI**  
*NUT H15 - INSERTED GASKET*  
*BRAIDED WIRE*

**F1/2"**  
**CON DADO H15**  
**GUARNIZIONE INSERITA**  
**TRECCIA 8 FILI**  
*NUT H15 - INSERTED GASKET*  
*BRAIDED WIRE*

SS 2012.150	F 1/2 x F1/2 MM 150	50		2,90
SS 2012.200	F 1/2 x F 1/2 MM 200	50		3,00
SS 2012.250	F 1/2 x F 1/2 MM 250	50		3,10
SS 2012.300	F 1/2 x F 1/2 MM 300	50		3,20
SS 2012.350	F 1/2 x F 1/2 MM 350	50		3,25
SS 2012.400	F 1/2 x F 1/2 MM 400	50		3,30
SS 2012.450	F 1/2 x F 1/2 MM 450	50		3,35
SS 2012.500	F 1/2 x F 1/2 MM 500	50		3,40
SS 2012.600	F 1/2 x F 1/2 MM 600	10		3,60
SS 2012.800	F 1/2 x F 1/2 MM 800	10		3,88
SS 2012.1000	F 1/2 x F 1/2 MM 1000	10		4,09

Art. 2012

Tubo Flessibile	Treccia INOX	CODICE PRODOTTO	DESCRIZIONE	UDC MINIMA	UNITÀ DI VENDITA	PREZZI EUR esc. IVA
<b>M 1/2"</b> <b>CORTO</b> SHORT M 1/2"	<b>F 3/8"</b> <b>CON DADO ALTO H15</b> <b>GUARNIZIONE INSERITA</b> <b>TRECCIA 8 FILI</b> NUT H15 - INSERTED GASKET BRAIDED WIRE	SD 2013.150	M1/2 x F3/8 MM 150	50		2,90
		SD 2013.200	M1/2 x F3/8 MM 200	50		2,95
		SD 2013.250	M1/2x F3/8 MM 250	50		3,10
		SD 2013.300	M1/2x F3/8 MM 300	50		3,15
		SD 2013.350	M1/2x F3/8 MM 350	50		3,20
		SD 2013.400	M1/2x F3/8 MM 400	50		3,25
		SD 2013.450	M1/2x F3/8 MM 450	50		3,30
		SD 2013.500	M1/2x F3/8 MM 500	50		3,35
		SD 2013.600	M1/2x F3/8 MM 600	10		3,75
		SD 2013.800	M1/2x F3/8 MM 800	10		3,95
		SD 2013.1000	M1/2x F3/8 MM 1000	10		4,15

Art. 2013





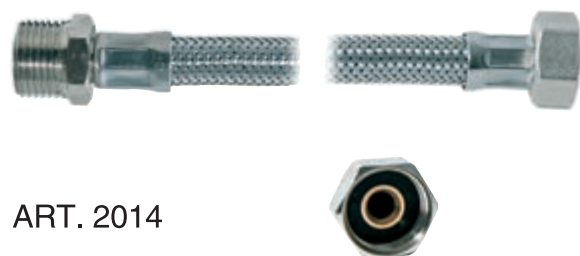





**M 1/2"**  
**CORTO**  
 SHORT M 1/2"

**F 1/2"**  
**CON DADO ALTO H15**  
**GUARNIZIONE INSERITA**  
**TRECCIA 8 FILI**  
 NUT H15 - INSERTED GASKET  
 BRAIDED WIRE



ART. 2014

PR 2014.150	M1/2 x F1/2 MM 150	50		2,95
PR 2014.200	M1/2 x F1/2 MM 200	50		3,00
PR 2014.250	M1/2 x F1/2 MM 250	50		3,15
PR 2014.300	M1/2 x F1/2 MM 300	50		3,20
PR 2014.350	M1/2 x F1/2 MM 350	50		3,25
PR 2014.400	M1/2 x F1/2 MM 400	50		3,30
PR 2014.450	M1/2 x F1/2 MM 450	50		3,35
PR 2014.500	M1/2 x F1/2 MM 500	50		3,40
PR 2014.600	M1/2 x F1/2 MM 600	10		3,80
PR 2014.800	M1/2 x F1/2 MM 800	10		4,00
PR 2014.1000	M1/2 x F1/2 MM 1000	10		4,20

Tubo Flessibile	Treccia INOX	CODICE PRODOTTO	DESCRIZIONE	UDC MINIMA	UNITÀ DI VENDITA	PREZZI EUR escl. IVA
<b>MP 1/2"</b> <b>MASCHIO PROLUNGATO</b> <i>EXTENDED M 1/2"</i>	<b>F 3/8"</b> <b>CON DADO ALTO H15</b> <b>GUARNIZIONE INSERITA</b> <b>TRECCIA 8 FILI</b> <i>NUT H15 - INSERTED GASKET</i> <i>BRAIDED WIRE</i>	MI 2015.150	MP 1/2 x F3/8 MM 150	50		3,30
		MI 2015.200	MP 1/2 x F3/8 MM 200	50		3,35
		MI 2015.250	MP 1/2 x F3/8 MM 250	50		3,40
		MI 2015.300	MP 1/2 x F3/8 MM 300	50		3,45
		MI 2015.350	MP 1/2 x F3/8 MM 350	50		3,50
		MI 2015.400	MP 1/2 x F3/8 MM 400	50		3,55
		MI 2015.450	MP 1/2 x F3/8 MM 450	50		3,60
		MI 2015.500	MP 1/2 x F3/8 MM 500	50		3,65
		MI 2015.600	MP 1/2 x F3/8 MM 600	10		3,75
		MI 2015.800	MP 1/2 x F3/8 MM 800	10		3,95
		MI 2015.1000	MP 1/2 x F3/8 MM 1000	10		4,15

Art. 2015



**MP 1/2"**  
**MASCHIO PROLUNGATO**  
*EXTENDED M 1/2"*

**F 1/2"**  
**CON DADO ALTO H15**  
**GUARNIZIONE INSERITA**  
**TRECCIA 8 FILI**  
*NUT H15 - INSERTED GASKET*  
*BRAIDED WIRE*



Art. 2016

VA 2016.150	MP 1/2 x F1/2 MM 150	50		3,35
VA 2016.200	MP 1/2 x F1/2 MM 200	50		3,40
VA 2016.250	MP 1/2 x F1/2 MM 250	50		3,45
VA 2016.300	MP 1/2 x F1/2 MM 300	50		3,50
VA 2016.350	MP 1/2 x F1/2 MM 350	50		3,55
VA 2016.400	MP 1/2 x F1/2 MM 400	50		3,60
VA 2016.450	MP 1/2 x F1/2 MM 450	50		3,65
VA 2016.500	MP 1/2 x F1/2 MM 500	50		3,70
VA 2016.600	MP 1/2 x F1/2 MM 600	10		3,80
VA 2016.800	MP 1/2 x F1/2 MM 800	10		4,00
VA 2016.1000	MP 1/2 x F1/2 MM 1000	10		4,20

Tubo Flessibile	Treccia INOX	CODICE PRODOTTO	DESCRIZIONE	UDC MINIMA	UNITÀ DI VENDITA	PREZZI EUR escl. IVA
<b>MP 1/2"</b> <b>MASCHIO PROLUNGATO</b> <b>CON ANELLO PTFE</b> <i>EXTENDED WITH RING M 1/2"</i>	<b>F 3/8"</b> <b>CON DADO ALTO H15</b> <b>GUARNIZIONE INSERITA</b> <b>TRECCIA 8 FILI</b> <i>NUT H15 - INSERTED GASKET</i> <i>BRAIDED WIRE</i>	VP 2017.150	MP 1/2 x F 3/8 MM 150	50		4,13
		VP 2017.200	MP 1/2 x F 3/8 MM 200	50		4,18
		VP 2017.250	MP 1/2 x F 3/8 MM 250	50		4,23
		VP 2017.300	MP 1/2 x F 3/8 MM 300	50		4,28
		VP 2017.350	MP 1/2 x F 3/8 MM 350	50		4,33
		VP 2017.400	MP 1/2 x F 3/8 MM 400	50		4,38
		VP 2017.450	MP 1/2 x F 3/8 MM 450	50		4,43
		VP 2017.500	MP 1/2 x F 3/8 MM 500	50		4,98
		VP 2017.600	MP 1/2 x F 3/8 MM 600	10		4,55
		VP 2017.800	MP 1/2 x F 3/8 MM 800	10		4,65
		VP 2017.1000	MP 1/2 x F 3/8 MM 1000	10		4,85

Art. 2017

**MP 1/2"**  
**MASCHIO PROLUNGATO**  
**CON ANELLO PTFE**  
*EXTENDED WITH RING M 1/2"*

**F 1/2"**  
**CON DADO ALTO H15**  
**GUARNIZIONE INSERITA**  
**TRECCIA 8 FILI**  
*NUT H15 - INSERTED GASKET*  
*BRAIDED WIRE*

		BT 2018.150	MP 1/2 x F1/2 MM 150	50		4,18
		BT 2018.200	MP 1/2 x F1/2 MM 200	50		4,23
		BT 2018.250	MP 1/2 x F1/2 MM 250	50		4,28
		BT 2018.300	MP 1/2 x F1/2 MM 300	50		4,33
		BT 2018.350	MP 1/2 x F1/2 MM 350	50		4,38
		BT 2018.400	MP 1/2 x F1/2 MM 400	50		4,43
		BT 2018.450	MP 1/2 x F1/2 MM 450	50		4,48
		BT 2018.500	MP 1/2 x F1/2 MM 500	50		4,55
		BT 2018.600	MP 1/2 x F1/2 MM 600	10		4,70
		BT 2018.800	MP 1/2 x F1/2 MM 800	10		4,75
		BT 2018.1000	MP 1/2 x F1/2 MM 1000	10		4,95

Art. 2018

**FLESSIBILI PER SCALDABAGNO, CALDAIE ED ELETTRODOMESTICI**  
 FLEXIBLES HOSES FOR WATER HEATERS, BOILERS AND HOUSEOLD APPLIANCES

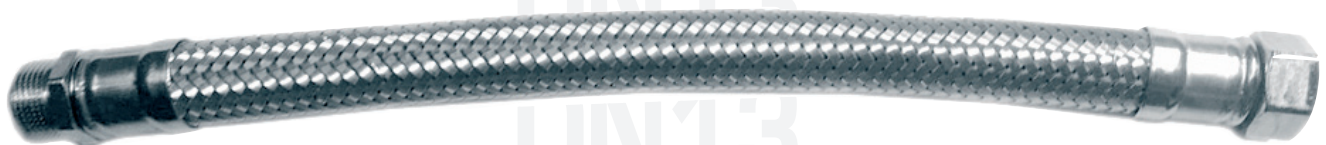







DISPONIBILE SU RICHIESTA CON TRECCIA TRICOLORE

## DATI TECNICI - TECHNICAL DATA:

Tubo flessibile trecciato made in Italy in acciaio Inox AISI 304 con interno in gomma alimentare EPDM utilizzato prevalentemente per il collegamento tra la rete idrica e i rubinetti singoli, gli scaldabagni, le pareti doccia attrezzate e le vasche idromassaggio oltre che ai rubinetti posti sulle cucine industriali. Tutti i flessibili sono raccordati con macchine automatiche ed il risultato e' l'assoluta precisione di ogni pezzo prodotto per una garanzia di totale qualità.

*Made in Italy braided hose in AISI 304 stainless steel with internal in non-toxic EPDM rubber, mainly used for the connection between the water mains and the single faucet, the boilers, the equipped shower sets and the hydromassage tubs, besides the taps are placed on industrial kitchens. All the hoses are produced with automatic machines and the result is the absolute precision of each produced piece for a total quality guarantee.*







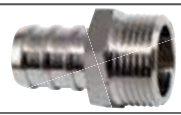



## CARATTERISTICHE - FEATURES:

TEMPERATURA INSTALLAZIONE INSTALLATION TEMPERATURE 	PRESSIONE D'ESERCIZIO WORKING PRESSURE 	PORTATA A 3 BAR FLOW RATE AT 3 BAR 	TEMPERATURA D'IMPIEGO WORKING TEMPERATURE 	FORO MINIMO PASSAGGIO D'ACQUA FITTING INNER DIAMETER 	RAGGIO CURVATURA MINIMO MINIMUM BENDING RADIUS 
da -5°C a +90°C	16 BAR	65 lit/min	-5°C - +90°C	9,3 mm	45 mm

## MATERIALI - MATERIALS











TUBO HOSE 	Ø INTERNO INNER Ø 13 mm	Ø ESTERNO OUTER Ø 18 mm	Treccia 9 fili Ø 0,22mm in acciaio Inox AISI 304 Tubo interno: gomma EPDM atossico. 9 wires braid Ø 0,22mm in stainless steel Inox AISI 304 Internal pipe: EPDM rubber, atoxic.
RACCORDI FITTINGS 	CW614N CW617N		Ottone CW614N CW617N nichelato o giallo Brass CW617N nickel plated or yellow
BUSSOLE SLEEVES 	Ø 20 mm		Acciaio Inox AISI 304 Stainless steel AISI 304



Tubo Flessibile	Treccia INOX	CODICE PRODOTTO	DESCRIZIONE	UDC MINIMA	UNITÀ DI VENDITA	PREZZI EUR <i>escl. IVA</i>
<b>F 1/2"</b>	<b>F 1/2"</b>	GC 313.150	F1/2x F1/2 MM 150	50		3,05
		GC 313.200	F1/2x F1/2 MM 200	50		3,26
		GC 313.250	F1/2x F1/2 MM 250	50		3,48
		GC 313.300	F1/2x F1/2 MM 300	50		3,78
		GC 313.350	F1/2x F1/2 MM 350	50		3,92
		GC 313.400	F1/2x F1/2 MM 400	50		4,13
		GC 313.450	F1/2x F1/2 MM 450	50		4,57
		GC 313.500	F1/2x F1/2 MM 500	50		4,98
		GC 313.600	F1/2x F1/2 MM 600	10		5,40
		GC 313.800	F1/2x F1/2 MM 800	10		5,81
		GC 313.1000	F1/2x F1/2 MM 1000	10		6,37







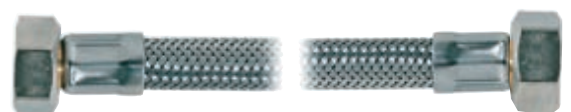





Art. 313

<b>F 1/2"</b>	<b>F 3/4"</b>	GD 314.150	F 1/2 x F 3/4 MM 150	50		3,30
		GD 314.200	F 1/2 x F 3/4 MM 200	50		3,52
		GD 314.250	F 1/2 x F 3/4. MM 250	50		3,73
		GD 314.300	F 1/2 x F 3/4 MM 300	50		3,98
		GD 314.350	F 1/2 x F 3/4 MM 350	50		4,12
		GD 314.400	F 1/2 x F 3/4 MM 400	50		4,38
		GD 314.450	F 1/2 x F 3/4 MM 450	50		4,83
		GD 314.500	F 1/2 x F 3/4 MM 500	50		5,24
		GD 314.600	F 1/2 x F 3/4 MM 600	10		5,65
		GD 314.800	F 1/2 x F 3/4 MM 800	10		6,09
		GD 314.1000	F 1/2 x F 3/4 MM 1000	10		6,62













Art. 314













Tubo Flessibile	Treccia INOX	CODICE PRODOTTO	DESCRIZIONE	UDC MINIMA	UNITÀ DI VENDITA	PREZZI EUR <i>escl. IVA</i>
<b>F 3/4"</b>	<b>F 3/4"</b>	GS 316.150	F 3/4 x F 3/4 MM 150	50		3,94
		GS 316.200	F 3/4 x F 3/4 MM 200	50		4,15
		GS 316.250	F 3/4 x F 3/4 MM 250	50		4,37
		GS 316.300	F 3/4 x F 3/4 MM 300	50		4,59
		GS 316.350	F 3/4 x F 3/4 MM 350	50		4,82
		GS 316.400	F 3/4 x F 3/4 MM 400	50		5,03
		GS 316.450	F 3/4 x F 3/4 MM 450	50		5,55
		GS 316.500	F 3/4 x F 3/4 MM 500	50		5,87
		GS 316.600	F 3/4 x F 3/4 MM 600	10		6,35
		GS 316.800	F 3/4 x F 3/4 MM 800	10		6,67
		GS 316.1000	F 3/4 x F 3/4 MM 1000	10		7,25

Art. 316

<b>M 3/4"</b>	<b>F 3/4"</b>	GM 318.150	M 3/4 x F 3/4 MM 150	50		4,26
		GM 318.200	M 3/4 x F 3/4 MM 200	50		4,48
		GM 318.250	M 3/4 x F 3/4. MM 250	50		4,70
		GM 318.300	M 3/4 x F 3/4 MM 300	50		4,92
		GM 318.350	M 3/4 x F 3/4 MM 350	50		5,35
		GM 318.400	M 3/4 x F 3/4 MM 400	50		5,80
		GM 318.450	M 3/4 x F 3/4 MM 450	50		6,30
		GM 318.500	M 3/4 x F 3/4 MM 500	50		6,75
		GM 318.600	M 3/4 x F 3/4 MM 600	10		7,18
		GM 318.800	M 3/4 x F 3/4 MM 800	10		7,75
		GM 318.1000	M 3/4 x F 3/4 MM 1000	10		7,95

Art. 318

Tubo Flessibile	Treccia INOX	CODICE PRODOTTO	DESCRIZIONE	UDC MINIMA	UNITÀ DI VENDITA	PREZZI EUR <i>escl. IVA</i>
<b>M 1/2"</b> <b>MASCHIO CORTO</b> <i>SHORT M 1/2"</i>	<b>F1/2"</b>	GR 322.150	M1/2 x F1/2 MM 150	50		3,08
		GR 322.200	M1/2 x F1/2 MM 200	50		3,29
		GR 322.250	M1/2 x F1/2 MM 250	50		3,55
		GR 322.300	M1/2 x F1/2 MM 300	50		3,79
		GR 322.350	M1/2 x F1/2 MM 350	50		3,98
		GR 322.400	M1/2 x F1/2 MM 400	50		4,18
		GR 322.450	M1/2 x F1/2 MM 450	50		4,62
		GR 322.500	M1/2 x F1/2 MM 500	50		5,02
		GR 322.600	M1/2 x F1/2 MM 600	10		5,45
		GR 322.800	M1/2 x F1/2 MM 800	10		5,95
		GR 322.1000	M1/2 x F1/2 MM 1000	10		6,56

Art. 322











**M1/2"**  
**MASCHIO CORTO**  
*SHORT M 1/2"*

**F 3/4"**



Art. 324

GT 324.150	M1/2 x F3/4 MM 150	50		3,33
GT 324.200	M1/2 x F3/4 MM 200	50		3,55
GT 324.250	M1/2 x F3/4 MM 250	50		3,78
GT 324.300	M1/2 x F3/4 MM 300	50		4,05
GT 324.350	M1/2 x F3/4 MM 350	50		4,24
GT 324.400	M1/2 x F3/4 MM 400	50		4,45
GT 324.450	M1/2 x F3/4 MM 450	50		4,93
GT 324.500	M1/2 x F3/4 MM 500	50		5,28
GT 324.600	M1/2 x 3/4 MM 600	10		5,88
GT 324.800	M1/2 x 3/4 MM 800	10		6,21
GT 324.1000	M1/2 x F3/4 MM 1000	10		6,85

Tubo Flessibile	Treccia INOX	CODICE PRODOTTO	DESCRIZIONE	UDC MINIMA	UNITÀ DI VENDITA	PREZZI EUR <i>esc. IVA</i>
<b>M 1/2"</b> <b>MASCHIO PROLUNGATO</b> <i>EXTENDED M 1/2"</i>	<b>F 1/2"</b>	GP 326.150	MP 1/2 x F1/2 MM 150	50		4,12
		GP 326.200	MP 1/2 x F1/2 MM 200	50		4,23
		GP 326.250	MP 1/2 x F1/2 MM 250	50		4,39
		GP 326.300	MP 1/2 x F1/2 MM 300	50		4,49
		GP 326.350	MP 1/2 x F1/2 MM 350	50		4,63
		GP 326.400	MP 1/2 x F1/2 MM 400	50		4,75
		GP 326.450	MP 1/2 x F1/2 MM 450	50		4,96
		GP 326.500	MP 1/2 x F1/2 MM 500	50		5,23
		GP 326.600	MP 1/2 x F1/2 MM 600	10		5,46
		GP 326.800	MP 1/2 x F1/2 MM 800	10		5,85
		GP 326.1000	MP 1/2 x F1/2 MM 1000	10		5,98



Art. 326











**M 1/2"**  
**MASCHIO PROLUNGATO**  
*EXTENDED M 1/2"*

**F 3/4"**

<b>M 1/2"</b> <b>MASCHIO PROLUNGATO</b> <i>EXTENDED M 1/2"</i>	<b>F 3/4"</b>	GZ 340.150	MP 1/2 x F3/4 MM 150	50		4,45
		GZ 340.200	MP 1/2 x F3/4 MM 200	50		4,67
		GZ 340.250	MP 1/2 x F3/4 MM 250	50		4,90
		GZ 340.300	MP 1/2 x F3/4 MM 300	50		5,05
		GZ 340.350	MP 1/2 x F3/4 MM 350	50		5,10
		GZ 340.400	MP 1/2 x F3/4 MM 400	50		5,38
		GZ 340.450	MP 1/2 x F3/4 MM 450	50		5,58
		GZ 340.500	MP 1/2 x F3/4 MM 500	50		5,78
		GZ 340.600	MP 1/2 x F3/4 MM 600	10		5,98
		GZ 340.800	MP 1/2 x F3/4 MM 800	10		6,07
		GZ 340.1000	MP 1/2 x F3/4 MM 1000	10		6,32













Art. 340

Tubo Flessibile	Treccia INOX	CODICE PRODOTTO	DESCRIZIONE	UDC MINIMA	UNITÀ DI VENDITA	PREZZI EUR <i>escl. IVA</i>
<b>F 1/2"</b>	<b>F 3/4" o 1/2"</b> <b>CURVA</b> <i>ELBOW F 3/4" o 1/2"</i>	GC 328.150	F1/2 x FC 3/4 MM 150	50		4,84
		GC 328.200	F1/2 x FC 3/4 MM 200	50		5,05
		GC 328.250	F1/2 x FC 3/4 MM 250	50		5,26
		GC 328.300	F1/2 x FC 3/4 MM 300	50		5,51
		GC 328.350	F1/2 x FC 3/4 MM 350	50		5,70
		GC 328400	F1/2 x FC 3/4 MM 400	50		5,92
		GC 328.450	F1/2 x FC 3/4 MM 450	50		6,36
		GC 328.500	F1/2 x FC 3/4 MM 500	50		6,76
		GC 328.600	F1/2 x FC 3/4 MM 600	10		719
		GC 328.800	F1/2 x FC 3/4 MM 800	10		7,60
		GC 328.1000	F1/2 x FC 3/4 MM 1000	10		8,15



Art. 328

<b>F 3/4"</b>	<b>F 3/4"</b> <b>CURVA</b> <i>ELBOW F 3/4"</i>	GF 330.150	F3/4 x FC 3/4 MM 150	50		5,06
		GF 330.200	F3/4 x FC 3/4 MM 200	50		5,26
		GF 330.250	F3/4 x FC 3/4 MM 250	50		5,48
		GF 330.300	F3/4 x FC 3/4 MM 300	50		5,70
		GF 330.350	F3/4 x FC 3/4 MM 350	50		5,90
		GF 330.400	F3/4 x FC 3/4 MM 400	50		6,12
		GF 330.450	F3/4 x FC 3/4 MM 450	50		6,56
		GF 330.500	F3/4 x FC 3/4 MM 500	50		7,00
		GF 330.600	F3/4 x FC 3/4 MM 600	10		7,43
		GF 330.800	F3/4 x FC 3/4 MM 800	10		7,86
		GF 330.1000	F3/4 x FC 3/4 MM 1000	10		8,84



Art. 330