



DN6  
DN6  
DN6  
DN6







DISPONIBILE SU RICHIESTA CON TRECCIA TRICOLORE

### DATI TECNICI - TECHNICAL DATA:

Tubo flessibile trecciato made in Italy in acciaio Inox AISI 304 con interno in gomma alimentare EPDM utilizzato per il collegamento tra la rete idrica e la rubinetteria sanitaria. Grazie alle dimensioni molto ridotte e alla pressatura su tutta la lunghezza della bussola, questo flessibile favorisce l'installazione su rubinetterie di qualsiasi design, specialmente quelle con un design molto minimale con degli spazi tecnici ridotti o poco accessibili. Tutti i flessibili sono raccordati con macchine automatiche ed il risultato è l'assoluta precisione di ogni pezzo prodotto per una garanzia di totale qualità.

Made in Italy braided hose in AISI 304 stainless steel with internal in non-toxic EPDM rubber, used for the connection between the water mains and the sanitary fittings. Thanks to the very small size and the pressing all along the entire length of the sleeve, this hose facilitates the installation on faucets of any design, especially on those with a very minimal design with reduced engineering spaces or not very accessible. All the hoses are produced with automatic machines and the result is the absolute precision of each produced piece for a total quality guarantee.











### CARATTERISTICHE - FEATURES:

TEMPERATURA INSTALLAZIONE INSTALLATION TEMPERATURE 	PRESSIONE D'ESERCIZIO WORKING PRESSURE 	PORTATA A 3 BAR 	TEMPERATURA D'IMPIEGO WORKING TEMPERATURE 	FORO MINIMO PASSAGGIO D'ACQUA FITTING INNER DIAMETER 	RAGGIO CURVATURA MINIMO 
da -5°C a +90°C	10 BAR	19 lit/min	-5°C - +90°C	4,7 mm	25 mm











### MATERIALI - MATERIALS

TUBO HOSE		Ø INTERNO INNER Ø 6 mm	Ø ESTERNO OUTER Ø 10 mm	Treccia 6 fili Ø 0,20mm in acciaio INOX AISI 304 Tubo interno: gomma EPDM atossico. 6 wires braid Ø 0,20mm in stainless steel INOX AISI 304 Internal pipe: EPDM rubber, atoxic.
RACCORDI FITTINGS		CW614N		Ottone CW614N e CW617N nichelato o giallo Brass CW614N and CW617N nickel plated or yellow
BUSSOLE		Ø 12 mm		Acciaio INOX AISI 304 Stainless steel AISI 304













Tubo Flessibile	Treccia INOX	CODICE PRODOTTO	DESCRIZIONE	UDC MINIMA	UNITÀ DI VENDITA	PREZZI EUR escl. IVA
<b>M 10</b>	<b>F 3/8"</b>	RR 006.150	M 10 x F3/8 MM 150	50		1,79
		RR 006.200	M 10 x F3/8 MM 200	50		1,89
		RR 006.250	M 10 x F3/8 MM 250	50		2,00
		RR 006.300	M 10 x F3/8 MM 300	50		2,10
		RR 006.350	M 10 x F3/8 MM 350	50		2,20
		RR 006.400	M 10 x F3/8 MM 400	50		2,33
		RR 006.450	M 10 x F3/8 MM 450	50		2,64
		RR 006.500	M 10 x F3/8 MM 500	50		2,74
		RR 006.600	M 10 x F3/8 MM 600	10		2,96
		RR 006.800	M 10 x F3/8 MM 800	10		3,26
		RR 006.1000	M 10 x F3/8 MM 1000	10		3,46

Art. 006

<b>M 10</b>	<b>F 1/2"</b>	MS 217.150	M 10 x F1/2 MM 150	50		1,85
		MS 217.200	M 10 x F1/2 MM 200	50		1,96
		MS 217.250	M 10 x F1/2 MM 250	50		2,06
		MS 217.300	M 10 x F1/2 MM 300	50		2,17
		MS 217.350	M 10 x F1/2 MM 350	50		2,28
		MS 217.400	M 10 x F1/2 MM 400	50		2,39
		MS 217.450	M 10 x F1/2 MM 450	50		2,49
		MS 217.500	M 10 x F1/2 MM 500	50		2,70
		MS 217.600	M 10 x F1/2 MM 600	10		2,91
		MS 217.800	M 10 x F1/2 MM 800	10		3,34
		MS 217.1000	M 10 x F1/2 MM 1000	10		3,63

Art. 217

SOLO PER CASE RUBINETTERIA





Tubo Flessibile	Treccia INOX	CODICE PRODOTTO	DESCRIZIONE	UDC MINIMA	UNITÀ DI VENDITA	PREZZI EUR <i>escl. IVA</i>
<b>ML 10</b>	<b>F 3/8"</b>	RS 008.150	ML 10 x F3/8 MM 150	50		2,04
		RS 008.200	ML 10 x F3/8 MM 200	50		2,14
		RS 008.250	ML 10 x F3/8 MM 250	50		2,26
		RS 008.300	ML 10 x F3/8 MM 300	50		2,36
		RS 008.350	ML 10 x F3/8 MM 350	50		2,46
		RS 008.400	ML 10 x F3/8 MM 400	50		2,57
		RS 008.450	ML 10 x F3/8 MM 450	50		2,68
		RS 008.500	ML 10 x F3/8 MM 500	50		2,89
		RS 008.600	ML10 x F3/8 MM 600	10		3,10
		RS 008.800	ML 10 x F3/8 MM 800	10		3,52
		RS 008.1000	ML 10 x F3/8 MM 1000	10		3,87



Art. 008

**ML 10**

**F 1/2"**

	RD 010.150	ML 10 x F1/2 MM 150	50		2,10
	RD 010.200	ML 10 x F1/2 MM 200	50		2,22
	RD 010.250	ML 10 x F1/2 MM 250	50		2,32
	RD 010.300	ML 10 x F1/2 MM 300	50		2,42
	RD 010.350	ML 10 x F1/2 MM 350	50		2,52
	RD 010.400	ML 10 x F1/2 MM 400	50		2,64
	RD 010.450	ML 10 x F1/2 MM 450	50		2,74
	RD 010.500	ML 10 x F1/2 MM 500	50		2,96
	RD 010.600	ML 10 x F1/2 MM 600	10		3,18
	RD 010.800	ML 10 x F1/2 MM 800	10		3,89
	RD 010.1000	ML 10 x F1/2 MM 1000	10		4,09

Art. 010

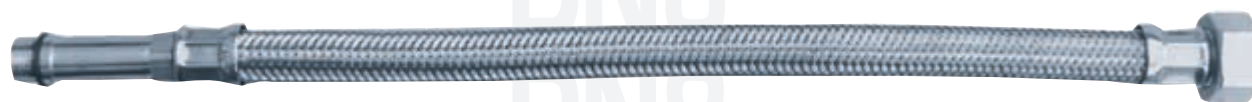







DISPONIBILE CON TRECCIA TRICOLORE

### DATI TECNICI - TECHNICAL DATA:

Tubo flessibile trecciato made in Italy in acciaio Inox AISI 304 con interno in gomma alimentare EPDM utilizzato per il collegamento tra la rete idrica e la rubinetteria sanitaria o cassette W.C. e adatto a qualsiasi altro impiego sanitario. Tutti i flessibili sono raccordati con macchine automatiche ed il risultato è l'assoluta precisione di ogni pezzo prodotto per una garanzia di totale qualità.

*Made in Italy braided hose in AISI 304 stainless steel with internal in EPDM rubber, used for the connection between the water mains and the sanitary fittings or W.C. flushing tanks. All the hoses are produced with automatic machines and the result is the absolute precision of each produced piece for a total quality guarantee.*











### CARATTERISTICHE - FEATURES:

TEMPERATURA INSTALLAZIONE <small>INSTALLATION TEMPERATURE</small> 	PRESSIONE D'ESERCIZIO <small>WORKING PRESSURE</small> 	PORTATA A 3 BAR <small>FLOW RATE AT 3 BAR</small> 	TEMPERATURA D'IMPIEGO <small>WORKING TEMPERATURE</small> 	FORO MINIMO PASSAGGIO D'ACQUA <small>FITTING INNER DIAMETER</small> 	RAGGIO CURVATURA MINIMO <small>MINIMUM BENDING RADIUS</small> 
da -5°C a +90°C	10 BAR	29 lit/min	-5°C - +90°C	6 mm	30 mm

### MATERIALI - MATERIALS







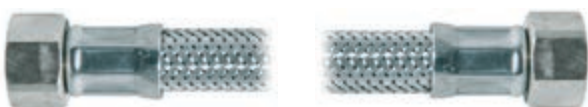



TUBO <small>HOSE</small> 	Ø INTERNO <small>INNER Ø</small> 8 mm	Ø ESTERNO <small>OUTER Ø</small> 12 mm	Treccia 7 fili Ø 0,22mm in acciaio Inox AISI 304 Tubo interno: gomma EPDM atossico. 7 wires braid Ø 0,22mm in stainless steel Inox AISI 304 Internal pipe: EPDM rubber, atoxic.
RACCORDI <small>FITTINGS</small> 	CW614N		Brass CW614N and CW617N nickel plated
BUSSOLE <small>SLEEVES</small> 	Ø 14 mm		Acciaio Inox AISI 304 Stainless steel AISI 304



Tubo Flessibile	Treccia INOX	CODICE PRODOTTO	DESCRIZIONE	UDC MINIMA	UNITÀ DI VENDITA	PREZZI EUR <i>escl. IVA</i>
<b>F 3/8"</b>	<b>F 3/8"</b>	MR 014.150	F3/8 x F3/8 MM 150	50		1,93
		MR 014.200	F3/8 x F3/8 MM 200	50		2,05
		MR 014.250	F3/8 x F3/8 MM 250	50		2,15
		MR 014.300	F3/8 x F3/8 MM 300	50		2,27
		MR 014.350	F3/8 x F3/8 MM 350	50		2,39
		MR 014.400	F3/8 x F3/8 MM 400	50		2,54
		MR 014.450	F3/8 x F3/8 MM 450	50		2,72
		MR 014.500	F3/8 x F3/8 MM 500	50		2,90
		MR 014.600	F3/8 x F3/8 MM 600	10		3,15
		MR 014.800	F3/8 x F3/8 MM 800	10		3,82
		MR 014.1000	F3/8 x F3/8 MM 1000	10		4,06













Art. 014

<b>F 1/2"</b>	<b>F 3/8"</b>	MN 015.150	F1/2 x F3/8 MM 150	50		1,85
		MN 015.200	F1/2 x F3/8 MM 200	50		1,96
		MN 015.250	F1/2 x F3/8 MM 250	50		2,06
		MN 015.300	F1/2 x F3/8 MM 300	50		2,17
		MN 015.350	F1/2 x F3/8 MM 350	50		2,28
		MN 015.400	F1/2 x F3/8 MM 400	50		2,39
		MN 015.450	F1/2 x F3/8 MM 450	50		2,49
		MN 015.500	F1/2 x F3/8 MM 500	50		2,70
		MN 015.600	F1/2 x F3/8 MM 600	10		2,91
		MN 015.800	F1/2 x F3/8 MM 800	10		3,34
		MN 015.1000	F1/2 x F3/8 MM 1000	10		3,63













Art. 015

Tubo Flessibile	Treccia INOX	CODICE PRODOTTO	DESCRIZIONE	UDC MINIMA	UNITÀ DI VENDITA	PREZZI EUR <i>escl. IVA</i>
<b>F 1/2"</b>	<b>F 1/2"</b>	FM 016.150	F1/2 x F1/2 MM 150	50		2,12
		FM 016.200	F1/2 x F1/2 MM 200	50		2,23
		FM 016.250	F1/2 x F1/2 MM 250	50		2,35
		FM 016.300	F1/2 x F1/2 MM 300	50		2,46
		FM 016.350	F1/2 x F1/2 MM 350	50		2,59
		FM 016.400	F1/2 x F1/2 MM 400	50		2,73
		FM 016.450	F1/2 x F1/2 MM 450	50		2,84
		FM 016.500	F1/2 x F1/2 MM 500	50		3,00
		FM 016.600	F1/2 x F1/2 MM 600	10		3,23
		FM 016.800	F1/2 x F1/2 MM 800	10		4,02
		FM 016.1000	F1/2 x F1/2 MM 1000	10		4,19







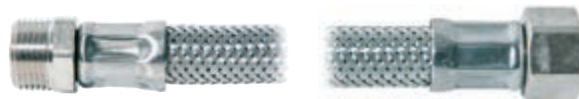





Art. 016

<b>M 3/8"</b>	<b>F 3/8"</b>	SF 017.150	M3/8 x F3/8 MM 150	50		2,02
		SF 017.200	M3/8 x F3/8 MM 200	50		2,14
		SF 017.250	M3/8 x F3/8 MM 250	50		2,25
		SF 017.300	M3/8 x F3/8 MM 300	50		2,37
		SF 017.350	M3/8 x F3/8 MM 350	50		2,48
		SF 017.400	M3/8 x F3/8 MM 400	50		2,62
		SF 017.450	M3/8 x F3/8 MM 450	50		2,74
		SF 017.500	M3/8 x F3/8 MM 500	50		2,90
		SF 017.600	M3/8 x F3/8 MM 600	10		3,14
		SF 017.800	M3/8 x F3/8 MM 800	10		3,93
		SF 017.1000	M3/8x F3/8 MM 1000	10		4,15













Art. 017

Tubo Flessibile	Treccia INOX	CODICE PRODOTTO	DESCRIZIONE	UDC MINIMA	UNITÀ DI VENDITA	PREZZI EUR <i>escl. IVA</i>
<b>MP 3/8"</b> <b>MASCHIO PROLUNGATO</b> <i>EXTENDED M3/8"</i>	<b>F 1/2"</b>	TT 066.150	MP3/8 x F1/2 MM 150	50		2,31
		TT 066.200	MP3/8 x F1/2 MM 200	50		2,38
		TT 066.250	MP3/8 x F1/2 MM 250	50		2,45
		TT 066.300	MP3/8 x F1/2 MM 300	50		2,56
		TT 066.350	MP3/8 x F1/2 MM 350	50		2,66
		TT 066.400	MP3/8 x F1/2 MM 400	50		2,76
		TT 066.450	MP3/8 x F1/2 MM 450	50		2,91
		TT 066.500	MP3/8 x F1/2 MM 500	50		3,05
		TT 066.600	MP3/8 x F1/2 MM 600	10		3,41
		TT 066.800	MP3/8 x F1/2 MM 800	10		3,95
		TT 066.1000	MP3/8 x F1/2 MM 1000	10		4,20







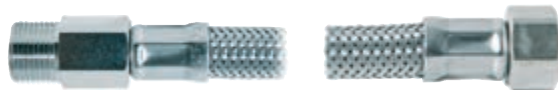





Art. 066

<b>MP 1/2"</b> <b>MASCHIO PROLUNGATO</b> <i>EXTENDED M 1/2"</i>	<b>F 3/8"</b>	TR 067.150	MP1/2 x F3/8 MM 150	50		2,36
		TR 067.200	MP1/2 x F3/8 MM 200	50		2,46
		TR 067.250	MP1/2 x F3/8 MM 250	50		2,51
		TR 067.300	MP1/2 x F3/8 MM 300	50		2,61
		TR 067.350	MP1/2 x F3/8 MM 350	50		2,71
		TR 067.400	MP1/2 x F3/8 MM 400	50		2,81
		TR 067.450	MP1/2 x F3/8 MM 450	50		2,96
		TR 067.500	MP1/2 x F3/8 MM 500	50		3,10
		TR 067.600	MP1/2 x F3/8 MM 600	10		3,45
		TR 067.800	MP1/2 x F3/8 MM 800	10		4,00
		TR 067.1000	MP1/2 x F3/8 MM 1000	10		4,30



Art. 067



Tubo Flessibile	Treccia INOX	CODICE PRODOTTO	DESCRIZIONE	UDC MINIMA	UNITÀ DI VENDITA	PREZZI EUR <i>escl. IVA</i>
<b>MP 1/2"</b> <b>MASCHIO PROLUNGATO</b> <i>EXTENDED M 1/2"</i>	<b>F 1/2"</b>	TP 068.150	MP1/2 x F1/2 MM 150	50		2,41
		TP 068.200	MP1/2 x F1/2 MM 200	50		2,48
		TP 068.250	MP1/2 x F1/2 MM 250	50		2,55
		TP 068.300	MP1/2 x F1/2 MM 300	50		2,65
		TP 068.350	MP1/2 x F1/2 MM 350	50		2,76
		TP 068.400	MP1/2 x F1/2 MM 400	50		2,86
		TP 068.450	MP1/2 x F1/2 MM 450	50		3,01
		TP 068.500	MP1/2 x F1/2 MM 500	50		3,15
		TP 068.600	MP1/2 x F1/2 MM 600	10		3,50
		TP 068.800	MP1/2 x F1/2 MM 800	10		4,08
		TP 068.1000	MP1/2 x F1/2 MM 1000	10		4,38



Art. 068

**MP 3/8"**  
**MASCHIO PROLUNGATO**  
*EXTENDED M 3/8"*





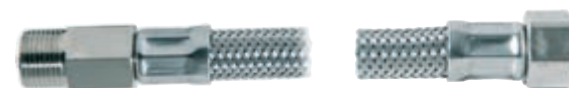

**F 3/8"**  
**CON GUARNIZIONE**  
**INSERITA**  
*INSERTED GASKET*

	 	TV 069.150	MP3/8 x F3/8 MM 150	50		2,47
		TV 069.200	MP3/8 x F3/8 MM 200	50		2,52
		TV 069.250	MP3/8 x F3/8 MM 250	50		2,58
		TV 069.300	MP3/8 x F3/8 MM 300	50		2,62
		TV 069.350	MP3/8 x F3/8 MM 350	50		2,76
		TV 069.400	MP3/8 x F3/8 MM 400	50		2,91
		TV 069.450	MP3/8 x F3/8 MM 450	50		3,06
		TV 069.500	MP3/8 x F3/8 MM 500	50		2,20
		TV 069.600	MP3/8 x F3/8 MM 600	10		3,60
		TV 069.800	MP3/8 x F3/8 MM 800	10		4,15
		TV 069.1000	MP3/8 x F3/8 MM 1000	10		4,55



Art. 069













Tubo Flessibile	Treccia INOX	CODICE PRODOTTO	DESCRIZIONE	UDC MINIMA	UNITÀ DI VENDITA	PREZZI EUR <i>escl. IVA</i>
<b>MP 1/2"</b> <b>MASCHIO PROLUNGATO</b> <i>EXTENDED M 1/2"</i>	<b>F 1/2"</b> <b>CON GUARNIZIONE</b> <b>INSERTITA</b> <i>INSERTED GASKET</i>	TZ 070.150	M1/2 x F1/2 MM 150	50		2,51
		TZ 070.200	M1/2 x F1/2 MM 200	50		2,61
		TZ 070.250	M1/2 x F1/2 MM 250	50		2,66
		TZ 070.300	M1/2 x F1/2 MM 300	50		2,76
		TZ 070.350	M1/2 x F1/2 MM 350	50		2,81
		TZ 070.400	M1/2 x F1/2 MM 400	50		2,96
		TZ 070.450	M1/2 x F1/2 MM 450	50		3,11
		TZ 070.500	M1/2 x F1/2 MM 500	50		3,25
		TZ 070.600	M1/2 x F1/2 MM 600	10		3,75
		TZ 070.800	M1/2 x F1/2 MM 800	10		4,20
		TZ 070.1000	M1/2 x F1/2 MM 1000	10		4,65

Art. 070











<b>M 3/8"</b> <b>MASCHIO CORTO</b> <i>SHORT MP 3/8"</i>	<b>F 1/2"</b> <b>CON GUARNIZIONE</b> <b>INSERTITA</b> <i>INSERTED GASKET</i>	ML 038.150	M 3/8 x F1/2 MM 150	50		2,16
		ML 038.200	M 3/8 x F1/2 MM 200	50		2,27
		ML 038.250	M 3/8 x F1/2 MM 250	50		2,32
		ML 038.300	M 3/8 x F1/2 MM 300	50		2,42
		ML 038.350	M 3/8 x F1/2 MM 350	50		2,53
		ML 038.400	M 3/8 x F1/2 MM 400	50		2,65
		ML 038.450	M 3/8 x F1/2 MM 450	50		2,75
		ML 038.500	M 3/8 x F1/2 MM 500	50		2,85
		ML 038.600	M 3/8 x F1/2 MM 600	10		3,15
		ML 038.800	M 3/8 x F1/2 MM 800	10		3,67
		ML 038.1000	M 3/8 x F1/2 MM 1000	10		3,97

Art. 038

Tubo Flessibile	Treccia INOX	CODICE PRODOTTO	DESCRIZIONE	UDC MINIMA	UNITÀ DI VENDITA	PREZZI EUR <i>escl. IVA</i>
<b>M 1/2"</b>	<b>F 3/8"</b>	LL 019.150	M1/2 x F3/8 MM 150	50		2,22
		LL 019.200	M1/2 x F3/8 MM 200	50		2,33
		LL 019.250	M1/2 x F3/8 MM 250	50		2,38
		LL 019.300	M1/2 x F3/8 MM 300	50		2,47
		LL 019.350	M1/2 x F3/8 MM 350	50		2,58
		LL 019.400	M1/2 x F3/8 MM 400	50		2,63
		LL 019.450	M 1/2 x F3/8 MM 450	50		2,76
		LL 019.500	M1/2 x F3/8 MM 500	50		2,5
		LL 019.600	M1/2 x F3/8 MM 600	10		3,30
		LL 019.800	M1/2 x F3/8 MM 800	10		3,87
		LL 019.1000	M1/2 x F3/8 MM 1000	10		4,10













Art. 019

<b>M 1/2"</b>	<b>F 1/2"</b>	LM 020.150	M1/2 x F1/2 MM 150	50		2,37
		LM 020.200	M1/2 x F1/2 MM 200	50		2,47
		LM 020.250	M1/2 x F1/2 MM 250	50		2,53
		LM 020.300	M1/2 x F1/2 MM 300	50		2,65
		LM 020.350	M1/2 x F1/2 MM 350	50		2,75
		LM 020.400	M1/2 x F1/2 MM 400	50		2,80
		LM 020.450	M1/2 x F1/2 MM 450	50		2,96
		LM 020.500	M1/2 x F1/2 MM 500	50		3,06
		LM 020.600	M1/2 x F1/2 MM 600	10		3,48
		LM 020.800	M1/2 x F1/2 MM 800	10		3,97
		LM 020.1000	M1/2 x F1/2 MM 1000	10		4,25



Art. 020

Tubo Flessibile	Treccia INOX	CODICE PRODOTTO	DESCRIZIONE	UDC MINIMA	UNITÀ DI VENDITA	PREZZI EUR <i>esc. IVA</i>
<b>F 1/2"</b> <b>CON CURVA</b> <i>ELBOW F 1/2"</i>	<b>F 3/8"</b>	MC 021.150	FC 1/2 x F3/8 MM 150	50		2,90
		MC 021.200	FC 1/2 x F3/8 MM 200	50		3,00
		MC 021.250	FC 1/2 x F3/8 MM 250	50		3,15
		MC 021.300	FC 1/2 x F3/8 MM 300	50		3,30
		MC 021.350	FC 1/2 x F3/8 MM 350	50		3,45
		MC 021.400	FC 1/2 x F3/8 MM 400	50		3,60
		MC 021.450	FC 1/2 x F3/8 MM 450	50		3,80
		MC 021.500	FC 1/2 x F3/8 MM 500	50		3,90
		MC 021.600	FC 1/2 x F3/8 MM 600	10		4,15
		MC 021.800	FC 1/2 x F3/8 MM 800	10		4,30
		MC 021.1000	FC 1/2 x F3/8 MM 1000	10		4,60

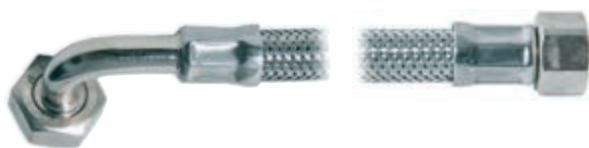

Art. 021











**F 1/2"**  
**CON CURVA**  
*ELBOW F 1/2"*

**F 1/2"**

CC 022.150	FC 1/2 x F1/2 MM 150	50		3,00
CC 022.200	FC 1/2 x F1/2 MM 200	50		3,10
CC 022.250	FC 1/2 x F1/2 MM 250	50		3,25
CC 022.300	FC 1/2 x F1/2 MM 300	50		3,45
CC 022.350	FC 1/2 x F1/2 MM 350	50		3,60
CC 022.400	FC 1/2 x F1/2 MM 400	50		3,70
CC 022.450	FC 1/2 x F1/2 MM 450	50		3,85
CC 022.500	FC 1/2 x F1/2 MM 500	50		3,95
CC 022.600	FC 1/2 x F1/2 MM 600	10		4,20
CC 022.800	FC 1/2 x F1/2 MM 800	10		4,35
CC 022.1000	FC 1/2 x F1/2 MM 1000	10		4,70



Art. 022





Tubo Flessibile	Treccia INOX	CODICE PRODOTTO	DESCRIZIONE	UDC MINIMA	UNITÀ DI VENDITA	PREZZI EUR <i>escl. IVA</i>
<b>M12 x 1 MM 18"</b>	<b>M 1/2"</b>	MV 028.150	M12 x M1/2 MM 150	50		2,33
		MV 028.200	M12 x M1/2 MM 200	50		2,41
		MV 028.250	M12 x M1/2 MM 250	50		2,49
		MV 028.300	M12 x M1/2 MM 300	50		2,63
		MV 028.350	M12 x M1/2 MM 350	50		2,69
		MV 028.400	M12 x M1/2 MM 400	50		2,77
		MV 028.450	M12 x M1/2 MM 450	50		2,95
		MV 028.500	M12 x M1/2 MM 500	50		3,05
		MV 028.600	M12 x M1/2 MM 600	10		3,16
		MV 028.800	M12 x M1/2 MM 800	10		3,46
		MV 028.1000	M12 x M1/2 MM 1000	10		3,77













Art. 028

**M12 x 1 MM 18"**

**F 3/8"**

		VL 029.150	M12 x F3/8 MM 150	50		2,17
		VL 029.200	M12 x F3/8 MM 200	50		2,28
		VL 029.250	M12 x F3/8 MM 250	50		2,40
		VL 029.300	M12 x F3/8 MM 300	50		2,51
		VL 029.350	M12 x F3/8 MM 350	50		2,63
		VL 029.400	M12 x F3/8 MM 400	50		2,86
		VL 029.450	M12 x F3/8 MM 450	50		2,96
		VL 029.500	M12 x F3/8 MM 500	50		3,09
		VL 029.600	M12 x F3/8 MM 600	10		3,31
		VL 029.800	M12 x F3/8 MM 800	10		3,51
		VL 029.1000	M12 x F3/8 MM 1000	10		3,86

Art. 029

Tubo Flessibile	Treccia INOX	CODICE PRODOTTO	DESCRIZIONE	UDC MINIMA	UNITÀ DI VENDITA	PREZZI EUR escl. IVA
<b>M12 X 1 MM 18"</b>	<b>F 1/2"</b>	VN 030.150	M12 x F1/2 MM 150	50		2,20
		VN 030.200	M12 x F1/2 MM 200	50		2,25
		VN 030.250	M12 x F1/2 MM 250	50		2,32
		VN 030.300	M12 x F1/2 MM 300	50		2,39
		VN 030.350	M12 x F1/2 MM 350	50		2,44
		VN 030.400	M12 x F1/2 MM 400	50		2,60
		VN 030.450	M12 x F1/2 MM 450	50		2,78
		VN 030.500	M12 x F1/2 MM 500	50		2,95
		VN 030.600	M12 x F1/2 MM 600	10		3,05
		VN 030.800	M12 x F1/2 MM 800	10		3,60
		VN 030.1000	M12 x F1/2 MM 1000	10		3,96















Art. 030

Tubo Flessibile	Treccia INOX
<b>M10 X 1 MM 18"</b>	<b>M 1/2"</b>













Art. 031

VR 031.150	M10 x M1/2 MM 150	50		2,23
VR 031.1200	M10 x M1/2 MM 200	50		2,28
VR 031.250	M10 x M1/2 MM 250	50		2,33
VR 031.300	M10 x M1/2 MM 300	50		2,38
VR 031.350	M10 x M1/2 MM 350	50		2,43
VR 031.100	M10 x M1/2 MM 400	50		2,49
VR 031.450	M10 x M1/2 MM 450	50		2,61
VR 031.500	M10 x M1/2 MM 500	50		2,75
VR 031.600	M10 x M1/2 MM 600	10		2,95
VR 031.800	M10 x M1/2 MM 800	10		3,10
VR 031.1000	M10 x M1/2 MM 1000	10		3,48

Tubo Flessibile	Treccia INOX	CODICE PRODOTTO	DESCRIZIONE	UDC MINIMA	UNITÀ DI VENDITA	PREZZI EUR escl. IVA
<b>M10 x 1 MM 18"</b>	<b>F 3/8"</b>	VS 032.150	M10 x F3/8 MM 150	50		1,90
		VS 032.200	M10 x F3/8 MM 200	50		1,95
		VS 032.250	M10 x F3/8 MM 250	50		2,05
		VS 032.300	M10 x F3/8 MM 300	50		2,10
		VS 032.350	M10 x F3/8 MM 350	50		2,15
		VS 032.400	M10 x F3/8 MM 400	50		2,25
		VS 032.450	M10 x F3/8 MM 450	50		2,37
		VS 032.500	M10 x F3/8 MM 500	50		2,45
		VS 032.600	M10 x F3/8 MM 600	10		2,97
		VS 032.800	M10 x F3/8 MM 800	10		3,15
		VS 032.1000	M10 x F3/8 MM 1000	10		3,35













Art. 032

<b>M10 x 1 MM 18"</b>	<b>F 1/2"</b>	MO 023.150	M10 x F1/2 MM 150	50		1,95
		MO 023.200	M10 x F1/2 MM 200	50		2,00
		MO 023.250	M10 x F1/2 MM 250	50		2,05
		MO 023.300	M10 x F1/2 MM 300	50		2,10
		MO 023.350	M10 x F1/2 MM 350	50		2,19
		MO 023.400	M10 x F1/2 MM 400	50		2,27
		MO 023.450	M10 x F1/2 MM 450	50		2,40
		MO 023.500	M10 x F1/2 MM 500	50		2,65
		MO 023.600	M10 x F1/2 MM 600	10		2,90
		MO 023.800	M10 x F1/2 MM 800	10		3,10
		MO 023.1000	M10 x F1/2 MM 1000	10		3,67



Art. 023

Tubo Flessibile	Treccia INOX	CODICE PRODOTTO	DESCRIZIONE	UDC MINIMA	UNITÀ DI VENDITA	PREZZI EUR escl. IVA
<b>ML10 x 1 MM 45" (6B)</b>	<b>F 3/8"</b>	VO 025.150	ML10 x F3/8 MM 150	50		2,09
		VO 025.200	ML10 x F3/8 MM 200	50		2,19
		VO 025.250	ML10 x F3/8 MM 250	50		2,25
		VO 025.300	ML10 x F3/8 MM 300	50		2,31
		VO 025.350	ML10 x F3/8 MM 350	50		2,41
		VO 025.400	ML10 x F3/8 MM 400	50		2,52
		VO 025.450	ML10 x F3/8 MM 450	50		2,67
		VO 025.500	ML10 x F3/8 MM 500	50		2,87
		VO 025.600	ML10 x F3/8 MM 600	10		3,08
		VO 025.800	ML10 x F3/8 MM 800	10		3,33
		VO 025.1000	ML10 x F3/8 MM 1000	10		3,86













Art. 025

**ML10 MM 45" (6B)**      **F 1/2"**











	FD 026.150	ML10 x F1/2 MM 150	50		2,16
	FD 026.200	ML10 x F1/2 MM 200	50		2,28
	FD 026.250	ML10 x F1/2 MM 250	50		2,38
	FD 026.300	ML10 x F1/2 MM 300	50		2,50
	FD 026.350	ML10 x F1/2 MM 350	50		2,63
	FD 026.400	ML10 x F1/2 MM 400	50		2,74
	FD 026.450	ML10 x F1/2 MM 450	50		2,96
	FD 026.500	ML10 x F1/2 MM 500	50		3,19
	FD 026.600	ML10 x F1/2 MM 600	10		3,41
	FD 026.800	ML10 x F1/2 MM 800	10		3,53
	FD 026.1000	ML10 x F1/2 MM 1000	10		XXX

Art. 026

Tubo Flessibile	Treccia INOX	CODICE PRODOTTO	DESCRIZIONE	UDC MINIMA	UNITÀ DI VENDITA	PREZZI EUR <i>escl. IVA</i>
<b>M10 x 1 MM 18" (6A)</b>	<b>LR ASTINA TUBO LISCIO Ø 10/9.7</b> <i>STRANGHT CONNECTION LR Ø 10/9.7</i>	OO 024.150	M10 x A10 MM 150	50		2,07
		OO 024.200	M10 x A10 MM 200	50		2,18
		OO 024.250	M10 x A10 MM 250	50		2,30
		OO 024.300	M10 x A10 MM 300	50		2,41
		OO 024.350	M10 x A10 MM 350	50		2,53
		OO 024.400	M10 x A10 MM 400	50		2,60
		OO 024.450	M10 x A10 MM 450	50		2,76
		OO 024.500	M10 x A10 MM 500	50		2,89
		OO 024.600	M10 x A10 MM 600	10		3,01
		OO 024.800	M10 x A10 MM 800	10		3,31
		OO 024.1000	M10 x A10 MM 1000	10		3,76













Art. 024

<b>ML10 x 1 MM 45" (6B)</b>	<b>LR ASTINA TUBO LISCIO Ø 10/9.7</b> <i>STRANGHT CONNECTION LR Ø 10/9.7</i>	VL 027.150	ML10 x A10 MM 150	50		2,20
		VL 027.200	ML10 x A10 MM 200	50		2,23
		VL 027.250	ML10 x A10 MM 250	50		2,35
		VL 027.300	ML10 x A10 MM 300	50		2,40
		VL 027.350	ML10 x A10 MM 350	50		2,45
		VL 027.400	ML10 x A10 MM 400	50		2,50
		VL 027.450	ML10 x A10 MM 450	50		2,57
		VL 027.500	ML10 x A10 MM 500	50		2,65
		VL 027.600	ML10 x A10 MM 600	10		2,97
		VL 027.800	ML10 x A10 MM 800	10		3,25
		VL 027.1000	ML10 x A10 MM 1000	10		3,50



Art. 027



Tubo Flessibile	Treccia INOX	CODICE PRODOTTO	DESCRIZIONE	UDC MINIMA	UNITÀ DI VENDITA	PREZZI EUR <i>escl. IVA</i>
<b>M 1/2"</b> <b>MASCHIO PROLUNGATO</b> <b>CON ANELLO PTFE</b> <i>EXTENDED WITH RING M 1/2"</i>	<b>F 3/8"</b> <b>CON GUARNIZIONE</b> <b>INSERITA</b> <i>INSERTED GASKET</i>	VT 033.150	MP 1/2 x F3/8 MM 150	50		2,93
		VT 033.200	MP 1/2 x F3/8 MM 200	50		3,00
		VT 033.250	MP 1/2x F3/8 MM 250	50		3,07
		VT 033.300	MP 1/2x F3/8 MM 300	50		3,14
		VT 033.350	MP 1/2x F3/8 MM 350	50		3,22
		VT 033.400	MP 1/2x F3/8 MM 400	50		3,29
		VT 033.450	MP 1/2x F3/8 MM 450	50		3,40
		VT 033.500	MP 1/2x F3/8 MM 500	50		3,56
		VT 033.600	MP 1/2x F3/8 MM 600	10		3,70
		VT 033.800	MP 1/2x F3/8 MM 800	10		3,80
		VT 033.1000	MP 1/2x F3/8 MM 1000	10		4,07



Art. 033











**M 1/2"**  
**MASCHIO PROLUNGATO**  
**CON ANELLO PTFE**  
*EXTENDED WITH RING M 1/2"*

**F 1/2"**  
**CON GUARNIZIONE**  
**INSERITA**  
*INSERTED GASKET*



Art. 034

VZ 034.150	MP 1/2 x F1/2 MM 150	50		3,10
VZ 034.200	MP 1/2 x F1/2 MM 200	50		3,17
VZ 034.250	MP 1/2 x F1/2 MM 250	50		3,24
VZ 034.300	MP 1/2 x F1/2 MM 300	50		3,31
VZ 034.350	MP 1/2 x F1/2 MM 350	50		3,39
VZ 034.400	MP 1/2 x F1/2 MM 400	50		3,46
VZ 034.450	MP 1/2 x F1/2 MM 450	50		3,57
VZ 034.500	MP 1/2 x F1/2 MM 500	50		3,72
VZ 034.600	MP 1/2 x F1/2 MM 600	10		3,86
VZ 034.800	MP 1/2 x F1/2 MM 800	10		3,96
VZ 034.1000	MP 1/2 x F1/2 MM 1000	10		4,15

Tubo Flessibile	Treccia INOX	CODICE PRODOTTO	DESCRIZIONE	UDC MINIMA	UNITÀ DI VENDITA	PREZZI EUR escl. IVA
<b>MP 1/2"</b> <b>MASCHIO PROLUNGATO CON ANELLO PTFE</b> <i>EXTENDED WITH RING M 1/2"</i>	<b>MB 10</b> <b>MASCHIO BICONO Ø 10 CALOTTA E OGIVA 3 PZ</b> <i>M 3/8 COMPRESSION CONNECT Ø 10 NUT AND RING 3 PCS</i>	VB 035.150	MP 1/2 x MB10 MM 150	50		3,23
		VB 035.200	MP 1/2 x MB10 MM 200	50		3,30
		VB 035.250	MP 1/2x MB10 MM 250	50		3,38
		VB 035.300	MP 1/2x MB10 MM 300	50		3,46
		VB 035.350	MP 1/2x MB10 MM 350	50		3,54
		VB 035.400	MP 1/2x MB10 MM 400	50		4,02
		VB 035.450	MP 1/2x MB10 MM 450	50		4,13
		VB 035.500	MP 1/2x MB10 MM 500	50		4,24
		VB 035.600	MP 1/2x MB10 MM 600	10		4,45
		VB 035.800	MP 1/2x MB10 MM 800	10		4,75
		VB 035.1000	MP 1/2x MB10 MM 1000	10		4,95













Art. 035











**M 3/8"**  
**CON ANELLO PTFE**  
*WITH RING PTFE*

**F 1/2"**



BB 040.150	M 3/8x F1/2 MM 150	50		2,68
BB 040.200	M 3/8 x F1/2 MM 200	50		2,78
BB 040.250	M 3/8 x F1/2 MM 250	50		2,82
BB 040.300	M 3/8 x F1/2 MM 300	50		2,92
BB 040.350	M 3/8 x F1/2 MM 350	50		3,02
BB 040.400	M 3/8 x F1/2 MM 400	50		3,08
BB 040.450	M 3/8 x F1/2 MM 450	50		3,18
BB 040.500	M 3/8 x F1/2 MM 500	50		3,28
BB 040.600	M 3/8 x F1/2 MM 600	10		3,48
BB 040.800	M 3/8 x F1/2 MM 800	10		3,80
BB 040.1000	M 3/8 x F1/2 MM 1000	10		4,03

Art. 040

Tubo Flessibile	Treccia INOX	CODICE PRODOTTO	DESCRIZIONE	UDC MINIMA	UNITÀ DI VENDITA	PREZZI EUR <i>escl. IVA</i>
<b>M 1/2"</b> <b>CON ANELLO PTFE</b> <i>WITH RING PTFE</i>	<b>F 3/8"</b>	BV 041.150	M 1/2 x F3/8 MM 150	50		2,60
		BV 041.200	M 1/2 x F3/8 MM 200	50		2,70
		BV 041.250	M 1/2x F3/8 MM 250	50		2,75
		BV 041.300	M 1/2x F3/8 MM 300	50		2,85
		BV 041.350	M 1/2x F3/8 MM 350	50		2,95
		BV 041.400	M 1/2x F3/8 MM 400	50		3,00
		BV 041.450	M 1/2x F3/8 MM 450	50		3,08
		BV 041.500	M 1/2x F3/8 MM 500	50		3,18
		BV 041.600	M 1/2x F3/8 MM 600	10		3,38
		BV 041.800	M 1/2x F3/8 MM 800	10		3,70
		BV 041.1000	M 1/2x F3/8 MM 1000	10		3,94



Art. 041

<b>M 1/2"</b> <b>CON ANELLO PTFE</b> <i>WITH RING PTFE</i>	<b>M 1/2"</b>	BR 042.150	M 1/2x M1/2 MM 150	50		2,83
		BR 042.200	M 1/2 x M1/2 MM 200	50		2,90
		BR 042.250	M 1/2 x M1/2 MM 250	50		2,97
		BR 042.300	M 1/2 x M1/2 MM 300	50		3,05
		BR 042.350	M 1/2 x M1/2 MM 350	50		3,15
		BR 042.400	M 1/2 x M1/2 MM 400	50		3,23
		BR 042.450	M 1/2 x M1/2 MM 450	50		3,33
		BR 042.500	M 1/2 x M1/2 MM 500	50		3,45
		BR 042.600	M 1/2 x M1/2 MM 600	10		3,59
		BR 042.800	M 1/2 x M1/2 MM 800	10		3,79
		BR 042.1000	M 1/2 x M1/2 MM 1000	10		3,99















Art. 042

Tubo Flessibile	Treccia INOX	CODICE PRODOTTO	DESCRIZIONE	UDC MINIMA	UNITÀ DI VENDITA	PREZZI EUR <i>escl. IVA</i>
<b>M 1/2"</b> <b>CON ANELLO PTFE</b> <i>WITH RING PTFE</i>	<b>F 3/8"</b> <b>CON GUARNIZIONE INSERITA</b> <i>INSERTED GASKET</i>	BV 043.150	M1/2 x F3/8 MM 150	50		2,82
		BZ 043.200	M1/2 x F3/8 MM 200	50		2,90
		BZ 043.250	M1/2x F3/8 MM 250	50		2,98
		BZ 043.300	M1/2x F3/8 MM 300	50		3,07
		BZ 043.350	M1/2x F3/8 MM 350	50		3,15
		BZ 043.400	M1/2x F3/8 MM 400	50		3,23
		BZ 043.450	M1/2x F3/8 MM 450	50		3,33
		BZ 043.500	M1/2x F3/8 MM 500	50		3,45
		BZ 043.600	M1/2x F3/8 MM 600	10		3,59
		BZ 043.800	M1/2x F3/8 MM 800	10		3,79
		BZ 043.1000	M1/2x F3/8 MM 1000	10		3,96











Art. 043

**M 1/2"**  
**CON ANELLO PTFE**  
*WITH RING PTFE*

**F 1/2"**  
**CON GUARNIZIONE INSERITA**  
*INSERTED GASKET*











		BG 044.150	M1/2 x F1/2 MM 150	50		2,98
		BG 044.200	M1/2 x F1/2 MM 200	50		3,05
		BG 044.250	M1/2 x F1/2 MM 250	50		3,12
		BG 044.300	M1/2 x F1/2 MM 300	50		3,19
		BG 044.350	M1/2 x F1/2 MM 350	50		3,26
		BG 044.400	M1/2 x F1/2 MM 400	50		3,35
		BG 044.450	M1/2 x F1/2 MM 450	50		3,47
		BG 044.500	M1/2 x F1/2 MM 500	50		3,60
		BG 044.600	M1/2 x F1/2 MM 600	10		3,75
		BG 044.800	M1/2 x F1/2 MM 800	10		3,95
		BG 044.1000	M1/2 x F1/2 MM 1000	10		4,20

Art. 044

Tubo Flessibile	Treccia INOX	CODICE PRODOTTO	DESCRIZIONE	UDC MINIMA	UNITÀ DI VENDITA	PREZZI EUR <i>escl. IVA</i>
<b>MB 10</b> <b>MASCHIO BICONE 10 o 12</b> <i>BICONE 10 o 12</i>	<b>M 1/2" o 3/8"</b>	VG 036.150	MB10x M1/2 MM 150	50		3,08
		VG 036.200	MB10x M1/2 MM 200	50		3,18
		VG 036.250	MB10x M1/2 MM 250	50		3,38
		VG 036.300	MB10x M1/2 MM 300	50		3,50
		VG 036.350	MB10x M1/2 MM 350	50		3,63
		VG 036.400	MB10x M1/2 MM 400	50		3,74
		VG 036.450	MB10x M1/2 MM 450	50		3,96
		VG 036.500	MB10x M1/2 MM 500	50		4,19
		VG 036.600	MB10x M1/2 MM 600	10		4,41
		VG 036.800	MB10x M1/2 MM 800	10		4,53
		VG 036.1000	MB10x M1/2 MM 1000	10		4,86



Art. 036

<b>MB 10</b> <b>MASCHIO BICONE 10 o 12</b> <i>BICONE 10 o 12</i>	<b>F 1/2" o 3/8"</b> <b>CON GUARNIZIONE INSERITA</b> <i>INSERTED GASKET</i>	VE 037.150	MB10 x F1/2 MM 150	50		3,05
		VE 037.200	MB10 x F1/2 MM 200	50		3,10
		VE 037.250	MB10 x F1/2 MM 250	50		3,25
		VE 037.300	MB10 x F1/2 MM 300	50		3,30
		VE 037.350	MB10 x F1/2 MM 350	50		3,45
		VE 037.400	MB10 x F1/2 MM 400	50		3,55
		VE 037.450	MB10 x F1/2 MM 450	50		3,67
		VE 037.500	MB10 x F1/2 MM 500	50		3,85
		VE 037.600	MB10 x F1/2 MM 600	10		3,97
		VE 037.800	MB10 x F1/2 MM 800	10		4,25
		VE 037.1000	MB10 x F1/2 MM 1000	10		4,50



Art. 037